

THIS IS THE TITLE

by

Ima Student

A Dissertation

Submitted to the Faculty of Purdue University

In Partial Fulfillment of the Requirements for the degree of

Doctor of Philosophy

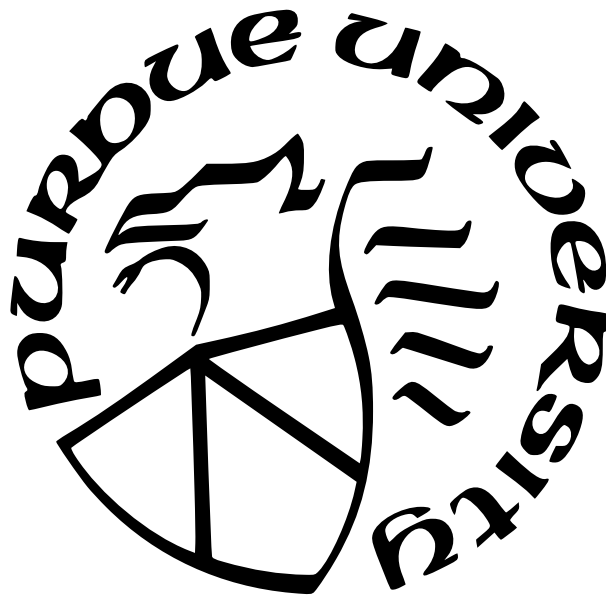

School of Electrical and Computer Engineering

West Lafayette, Indiana

December 2022

**THE PURDUE UNIVERSITY GRADUATE SCHOOL
STATEMENT OF COMMITTEE APPROVAL**

Dr. John Doe, Chair

School of Aeronautics and Astronautics

Dr. Jane Doe

School of Aeronautics and Astronautics

Dr. Jim Doe

School of Aeronautics and Astronautics

Approved by:

Dr. Buck Doe

To graduate students

ACKNOWLEDGMENTS

Purdue University's Engineering Computer Network and Graduate School helped fund PurdueThesis development.

PREFACE

This is the preface.

TABLE OF CONTENTS

LIST OF TABLES	13
LIST OF FIGURES	14
LIST OF LISTINGS	16
LIST OF PROTOCOLS	17
LIST OF SCHEMES	18
LIST OF SYMBOLS	19
ABBREVIATIONS	20
NOMENCLATURE	21
GLOSSARY	22
ABSTRACT	24
1 INTRODUCTION	25
1.1 Typographic Conventions	25
1.2 Writing in English Information	27
1.2.1 Logical punctuation	27
1.2.2 Serial comma	27
1.3 L ^A T _E X-related information	28
1.3.1 Input reading rules	28
1.3.2 Input preparation conventions	28
1.4 Filenames	30

1.5	Special input characters	31
1.6	Spacing after periods	31
1.7	Five kinds of dashes	32
2	DO NOT USE THESE PACKAGES	34
3	SUMMARY	35
3.1	First Section	35
4	RECOMMENDATIONS	36
5	TEST ENVIRONMENTS AND PER-CHAPTER REFERENCES	37
	References	38
	REFERENCES	39
A	ABOUT THE APPENDICES	49
A.1	Paragraphs	49
A.2	Section Heading	50
A.2.1	Subsection heading	50
	Subsubsection heading	50
A.3	Text math	51
B	BUGS	52
B.1	These bugs need to be looked at	52
B.2	These bugs are waiting on a reply from someone other than Mark Senn	53
B.3	These bugs have been rejected or fixed	53

C	CHECK MARGINS	54
D	CHAPTER APPENDICES	56
	D.1 This is a section heading	57
	D.A This is a chapter appendix	57
E	CITATIONS AND REFERENCES	58
	E.1 Citations	58
	E.2 References	59
F	COMMON MISTAKES	62
	F.1 Headings	62
	F.2 Mathematics	62
	F.2.1 Put a little extra horizontal space before dx	62
	F.3 Text	63
	F.3.1 e.g.,	63
	F.3.2 “et al.” is an abbreviation	63
	F.3.3 i.e.,	64
G	DEFINING COMMANDS	65
H	FIGURES	66
I	FREQUENTLY ASKED QUESTIONS	80
	I.1 These questions need to be answered	80
	I.2 These questions are waiting on a reply from someone other than Mark Senn	80

I.3	These questions have been answered	80
J	GRAPHICS	82
J.1	MATLAB programming language	82
J.2	METAPOST programming language	83
J.2.1	Tally example	85
J.3	Python programming language	88
J.4	R programming language	89
J.5	TikZ & L ^A T _E X package	91
J.5.1	Clock example	91
J.5.2	Counter example	93
J.5.3	Fourier transform example	94
J.5.4	Glider example	97
J.5.5	Tree example	98
J.5.6	Yin and yang example	99
J.6	Wolfram Language (Mathematica uses this)	100
K	IGNORE THESE REFERENCES—THEY ARE WRONG	102
L	LOGOS	103
M	MISCELLANEOUS	105
N	NUMBERS AND UNITS	106
N.1	Number Examples	106

N.2	Unit Examples	106
N.3	Combined Number and Unit Examples	107
N.4	Binary Prefixes	108
N.5	Decimal Prefixes	109
N.6	SI Units	110
N.7	Complete List of Units	111
O	RESOURCES	130
P	TABLES	131
Q	SPECIAL CHARACTERS	149
R	TESTING (THIS APPENDIX IS USED FOR TESTING, DOES THIS VERY, VERY, VERY, VERY, VERY, VERY, VERY, VERY, VERY, VERY, VERY, VERY, VERY, LONG TITLE LOOK OK?)	150
R.1	Figure Captions	150
R.2	Apostrophes	150
R.3	Citations	151
R.4	Footnote	151
R.5	Section heading in SMALLCAPS font	152
R.6	To-do notes	152
S	TEXT	154
S.1	Color	154
S.2	Description, enumerate, and itemize environments	154

S.3	Computer program listings	156
S.4	Frenchspacing	157
S.5	Multiple Columns	158
S.6	Words	159
T	ASTRONOMY	161
U	BIOLOGY	162
V	CHEMISTRY	163
V.1	Chemical Diagrams	163
V.2	Chemical Equations	163
V.3	Chemical Figures	166
V.4	Chemical Schemes	167
W	COMPUTER SCIENCE	170
W.1	Protocol examples	170
X	ELECTRICAL ENGINEERING	171
X.1	Amplifiers	171
X.2	Kalman Filter System Model	172
Y	LINGUISTICS	177
Y.1	Demonstrate the example and examples environments	177
Z	MATHEMATICS	178
Z.1	Standard Functions	179

Z.2	English Words in Math	180
Z.3	Text Math	180
Z.4	Displayed Equations	180
Z.4.1	equation environment	181
Z.4.2	multline environment	185
Z.4.3	gather environment	186
Z.4.4	align environment	187
Z.4.5	alignat environment	190
Z.4.6	flalign environment	192
Z.4.7	split environment	193
Z.5	Theorem-like environments	193
Z.6	Examples	195
Z.6.1	Bayes' Theorem	195
Z.6.2	Nicomachus's theorem	195
Z.6.3	Prime Number Theorem	196
Z.6.4	Quantum Mechanics	196
Z.6.5	Question in String Theory / Mass of States / Number Operator	197
AAMUSIC	199
VITA	200
PUBLICATION(S)	201

LIST OF TABLES

N.1	Units and Corresponding Symbols	111
P.1	The first three American Presidents.	131
P.2	The first three American Presidents. This caption is much, much, much, much, much, much, much, much, much, much, much, much, much longer.	132
P.3	The first three American Presidents with horizontal and vertical lines	133
P.4	C Bitwise Operators	134
P.5	Participant descriptors for twelve practitioners engaged in co-creation activities	135
P.6	State Abbreviations	136
P.7	Sidewaystable of the first three American Presidents.	142
P.8	Two tables can be placed vertically in a sidewaystable environment.	144
P.9	This is the second table in the sideways environment.	144
P.10	Live Guitar Open String Testing Data - Pitch (f_0)	146
P.11	First tally table. Use this method.	147
P.12	Second tally table. Don't use this method. The method used in the first tally table is easier to understand.	147
P.13	Third tally table. Don't use this method. The method used in the first tally table is easier to understand.	148

LIST OF FIGURES

1.1	Lua \LaTeX System Flowchart	26
H.1	Allocation to Common Edge for $p(x_i) = 1 - e^{-x_i z}$	67
H.2	By default figures are not centered. This is a long caption to demonstrate that captions are single spaced. This is a long caption to demonstrate that captions are single spaced.	68
H.3	Use <code>\centering</code> to center figures.	69
H.4	This is another figure.	69
H.5	This figure has two subfigures arranged horizontally.	70
H.6	This figure has two subfigures arranged vertically.	71
H.7	This figure has four parts.	72
H.8	A big “ $\sqrt{2}$ ”. \LaTeX can make output big enough for T-shirts or posters. Square roots are printed with space before them, I put some negative horizontal space before this one to center it.	73
H.9	Allocation to Common Edge for $p(x_i) = 1 - e^{-x_i z}$	74
H.10	Test figure 1 of 20.	75
H.11	Test figure 2 of 20.	75
H.12	Test figure 3 of 20.	75
H.13	Test figure 4 of 20.	75
H.14	Test figure 5 of 20.	75
H.15	Test figure 6 of 20.	75
H.16	Test figure 7 of 20.	76
H.17	Test figure 8 of 20.	76
H.18	Test figure 9 of 20.	76
H.19	Test figure 10 of 20.	76
H.20	Test figure 11 of 20.	76
H.21	Test figure 12 of 20.	76
H.22	Test figure 13 of 20.	76
H.23	Test figure 14 of 20.	77
H.24	Test figure 15 of 20.	77

H.25 Test figure 16 of 20.	77
H.26 Test figure 17 of 20.	77
H.27 Test figure 18 of 20.	77
H.28 Test figure 19 of 20.	77
H.29 Test figure 20 of 20.	77
R.1 This is the caption. This is the caption. This is the caption. This is the caption. This is the caption. This is the caption.	150
X.1 Kalman filter system model	173

LIST OF LISTINGS

S.1	This is the caption.	156
S.2	A Pascal Program	156

LIST OF PROTOCOLS

W.1 This is the first protocol caption.	170
W.2 This is the second protocol caption.	170

LIST OF SCHEMES

V.1	This is the first scheme caption.	167
V.2	This is the second scheme caption.	167
V.3	The Fischer indole synthesis	168
V.4	The Cannizzaro reaction.	169

LIST OF SYMBOLS

m mass

v velocity

ABBREVIATIONS

abbr	abbreviation
bcf	billion cubic feet
BMOC	big man on campus

NOMENCLATURE

alanine 2-Aminopropanoic acid

gasoline a transparent, petroleum-derived flammable liquid that is used primarily as a fuel in most spark-ignited internal combustion engines [1]

valine 2-Amino-3-methylbutanoic acid

Valvoline Valvoline Inc. is an American manufacturer and distributor of Valvoline-brand automotive oil, additives, and lubricants. It also owns the Valvoline Instant Oil Change and Valvoline Express Care chains of car repair centers. As of 2016, it is the second largest oil change service provider in the United States with 10% market share and 1,050 locations. [2]

you can divide these into categories if you want

Biology

alanine 2-Aminopropanoic acid

valine 2-Amino-3-methylbutanoic acid

Transportation

gasoline a transparent, petroleum-derived flammable liquid that is used primarily as a fuel in most spark-ignited internal combustion engines [1]

Valvoline Valvoline Inc. is an American manufacturer and distributor of Valvoline-brand automotive oil, additives, and lubricants. It also owns the Valvoline Instant Oil Change and Valvoline Express Care chains of car repair centers. As of 2016, it is the second largest oil change service provider in the United States with 10% market share and 1,050 locations. [2]

GLOSSARY

philtrum	the groove between the nose and upper lip
septem	the cartilage in the nose that separates the nostrils
supercalifragilisticexpialidocious	a nonsense word, originally used esp. by children, and typically expressing excited approbation: fantastic, fabulous [3]
test entry	This is a a long test sentence. This is a a long test sentence. This is a a long test sentence. This is a a long test sentence. This is a a long test sentence. This is a a long test sentence. This is a a long test sentence. This is a a long test sentence. This is a a long test sentence. This is a a long test sentence. This is a a long test sentence. This is a a long test sentence.

ABSTRACT

PurdueThesis is a L^AT_EX document class used for master's bypass reports, master's theses, PhD dissertations, and PhD preliminary reports. This template demonstrates how to use PurdueThesis.

1. INTRODUCTION

$T_{\text{E}}\text{X}$ is a typesetting system for the creation of beautiful books—and especially for books that contain lots of mathematics [4, page v].

\LaTeX is a software system for typesetting documents [5, back cover]. It extends $T_{\text{E}}\text{X}$ with more natural chapter, section, etc. commands that are easier to use. \LaTeX has document classes for articles, books, reports, etc.

PurdueThesis (*PuTh* for short—rhymes with tooth) is a \LaTeX document class used for Purdue theses, dissertations, masters bypass reports, and PhD preliminary reports. This template demonstrates how to use *PurdueThesis*. *PurdueThesis* is intended to support all Purdue campuses, programs, and graduate degrees.

Figure 1.1 shows the \LaTeX System Flowchart. Overleaf [6] uses `latexmk` [7] to run `biblatex` or `bibtex`, `makeindex`, and `lualatex` automatically so the minimum amount of work is done. On Linux, MacOS, and Windows you can run the programs individually or use `latexmk`—I recommend using `latexmk`.

The Thesis and Dissertation Office [8] wrote a formatting manual and Microsoft Word templates for Purdue theses.

1.1 Typographic Conventions

The following typographic conventions are used in this document. These conventions were influenced by [9]–[11]. There are no quotes in the typographic conventions.

Emphasis, *First Use*, and *Title*

Emphasis: You *must* do this.

First Use: The sensor was installed in an *ekayak*. An *ekayak* is an electric kayak.

Title: He read *The Grapes of Wrath* and watched *Citizen Kane*.

Keyboard Keys

`Control` + `A` means press the Control key and A key at the same time. `A` `B`

means press key A and then press key B.

Literal Element

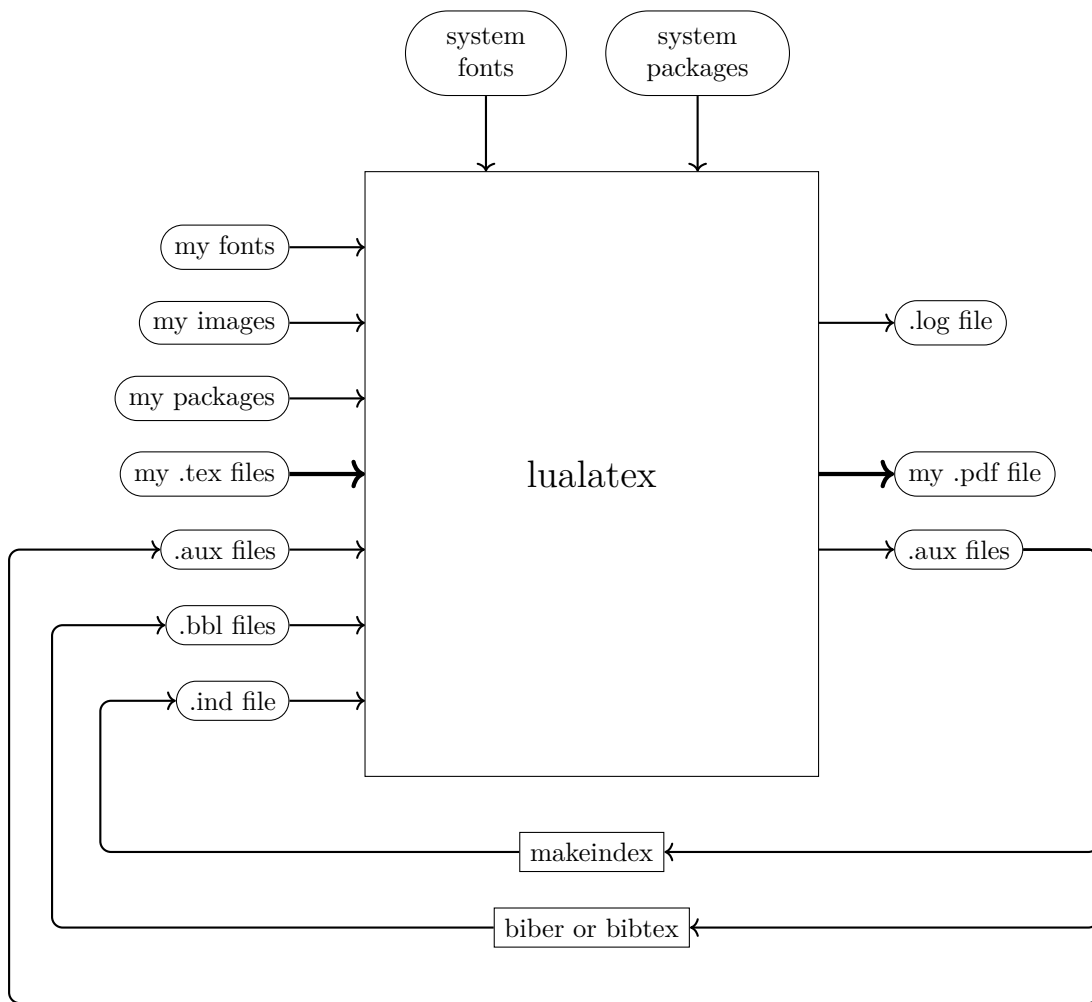

Figure 1.1. Lua_lTeX System Flowchart

Literal elements include checkboxes, code, environment variables, file names, function names, L^AT_EX input, output, variable names, and verbatim input (except for commands typed on the command line). `\` is used to indicate a space if it is not clear where spaces are.

`Menu` `>>` `Submenu` `>>` `Item`

To make sure smooth scrolling is on go to `Edit` `>>` `Settings` and make sure the `Use smooth scrolling` checkbox is checked.

Placeholder

Placeholders need to be replaced with real input.

shell command

Command typed on the command line by the user.

1.2 Writing in English Information

1.2.1 Logical punctuation

I use logical punctuation [12]:

The sign said “Buses Only”.

instead of

The sign said “Buses Only.”

so quoted material, and only quoted material, is inside quotes. This is relatively new and not many people use it. Your major professor may not like this style. Check with them before you decide to use this.

1.2.2 Serial comma

I use the serial comma:

apple, berry, and cherry

instead of

apple, berry and cherry

because I find it easier to see the list items when they are separated by commas. The serial comma is also known as the Oxford comma, Harvard comma, or series comma.

1.3 L^AT_EX-related information

1.3.1 Input reading rules

L^AT_EX uses the following rules when reading input:

- the end of a line is equivalent to a space
- spaces at the beginning of a line are ignored
- a blank line ends a paragraph

1.3.2 Input preparation conventions

In L^AT_EX typing

As $\backslash(h\backslash)$ approaches 0 in the limit, the last fraction can be shown to go to zero. This is true because the area of the red portion of excess region is less than or equal to the area of the tiny black-bordered rectangle. More precisely, $\backslash[\backslashleft|f(x)-\frac{A(x+h)-A(x)}{h}\right|-\frac{\left|\text{Red Excess}\right|}{h}\leq\frac{h\big(f(x+h_1)-f(x+h_2)\big)}{h}=f(x+h_1)-f(x+h_2),\backslash]$ where $\backslash(x+h_1\backslash)$ and $\backslash(x+h_2\backslash)$ are points where $\backslash(f\backslash)$ reaches its maximum and its minimum, respectively, in the interval $\backslash([x,x+h]\backslash)$.

gives exactly the same output as

As $\backslash(h\backslash)$ approaches 0 in the limit, the last fraction can be shown to go to zero. This is true because the area of the red portion of excess region is less than or equal to the area of the tiny black-bordered rectangle. More precisely,

$$\begin{aligned} &\backslash[\\ &\quad \backslashleft | \\ &\quad \quad f(x) \\ &\quad - \\ &\quad \quad \frac{A(x+h)-A(x)}{h} \\ &\quad \backslashright | \\ &\quad - \\ &\quad \frac{\left|\backslash\text{Red Excess}\backslash\right|}{h} \\ &\quad \backslashle \\ &\quad \frac{h\big(f(x+h_1)-f(x+h_2)\big)}{h} \\ &= \end{aligned}$$

```

f(x+h_1)
-
f(x+h_2),
\]
where \(\x+h_1\)
and \(\x+h_2\) are points where \(\f\) reaches its maximum and its minimum,
respectively,
in the interval \([x, x + h]\).

```

I've used L^AT_EX over 30 years and use these personal conventions to prepare input. Using these conventions leads to many short lines, but I find those easier to read and edit. Do whatever works best for you.

start input lines with

the first word of a sentence

(

and

but

from

or

to

end input lines with

sentence-ending periods

phrase-ending commas

phrase-ending colons

phrase-ending semicolons

)

\

\[*dimension*]

put these on a line of their own

\begin{*environment name*}

`\end{environment name}`
short parenthetical remark

1.4 Filenames

There are several different name styles for file names:

Name	Why it's called that
camelCase	C is taller than surrounding characters, looks like camel's hump
kebab-case	letters appear to be slid on shish-kebab skewer, no <code>Shift</code> needed
PascalCase	popular in the Pascal programming language
snake_case	looks like a snake, is kebab-case except - is changed to _

I recommend you only use kebab-case file names that consist of only lowercase letters, zero or more digits, zero or more - characters (but no consecutive - characters), and a single period. You won't need to use `Shift` then.

Do not put spaces in your file names. It makes it easier to run your thesis on other computer operating systems. Linux, MacOS, and Windows are operating systems.

I like to start all chapter file names with `ch-`. Chapter names are everything from the beginning of the thesis through the last chapter. Chapters include all front matter in addition to all chapters.

Appendix names start with `ap-` and are everything after the last chapter including any bibliography, colophon, indices, and vita.

Graphics files specific to your thesis start with `gr-` and go in the graphics folder. Non-thesis graphics files retain their normal names and go in the graphics folder.

\LaTeX package files specific to your thesis start with `pa-` and go in the packages folder. Non-thesis packages retain their normal names and go in the packages folder.

1.5 Special input characters

These input characters are special:

#	\$	%	&	\	^	_	{	}	~
Type									
\#	\\$	\%	\&	\$\$\backslash\$	\char'136	_	\{	\}	\char'176
to get this output									
#	\$	%	&	\	^	_	{	}	~

1.6 Spacing after periods

A lowercase letter followed by a period is treated like the end of a sentence with approximately two spaces following the period. To not make it the end of a sentence put \ or ~ after the period. See table below.

An uppercase letter followed by a period is treated like a person's middle initial with approximately one space following the period. To make it the end of a sentence put \@ before the period. See table below.

Input	Output	Comment
Dr. Smith	Dr. Smith	too much space after Dr.
Dr.\ Smith	Dr. Smith	correct, Dr. and Smith can be on different lines
Dr.~Smith	Dr. Smith	correct, Dr. and Smith will be on same line, I recommend using this
at NASA. The	at NASA. The	not enough space after NASA.
at NASA\@. The	at NASA. The	correct

(I thought the following was too confusing. One or more *lowercase/uppercase* letters followed by a period is treated like *the end of a sentence/a person's middle initial* with approximately *two/one* space(s) following the period.)

(I thought some people might think the following is too informal or nonstandard. It is pretty confusing also. One or more ^{uppercase}/_{lowercase} letters followed by a period is treated like a middle initial ^{the end of a sentence} with approximately ^{one}/_{two} space(s) following the period.)

1.7 Five kinds of dashes

There are five kinds of dashes

Name	Input	Output	Width in Points (72.27 points/inch)
hyphen	- (one hyphen)	-	3.91667pt
endash	-- (two hyphens)	–	5.87498pt
emdash	--- (three hyphens)	—	11.75pt
figure dash	\FigureDash	-	5.87498pt
minus sign	\(-\)	−	9.33336pt

hyphen The hyphen is a punctuation mark used to join words and to separate syllables of a single word [13].

Input	Output	Comment
- (one hyphen)	-	
son-in-law	son-in-law	used to join words
gas-oline	gas-oline	used to separate syllables, L ^A T _E X hyphenates words automatically so you may not ever use this

endash The endash [14] is used for

Input	Output	Comment
-- (two hyphens)	–	
The Purdue--IU game	The Purdue–IU game	conflict
Perth--Dubai--Boston	Perth–Dubai–Boston	connection
Teal Road runs East--West	Teal Road runs East–West	direction
ages 21--65	ages 21–65	age range
June--July 1967	June–July 1967	month range
pages 38--55	pages 38–55	page range
1:15--2:15 p.m.	1:15–2:15 p.m.	time range
Purdue beat IU 35--28	Purdue beat IU 35–28	scores

emdash The emdash [15] is used for

	---	(three hyphens)	—
Input	the usual suspects---	Larry, Moe, and Curly	
Output	the usual suspects—	Larry, Moe, and Curly	
Comment			— acts like colon
Input	Larry, Moe, and Curly---	the usual suspects	
Output	Larry, Moe, and Curly—	the usual suspects	
Comment			inverse function of colon
Input	three people---	Larry, Moe, and Curly---	%
	are the usual suspects		
Output	three people—	Larry, Moe, and Curly—	are the usual suspects
Comment	first —	acts as (,	second — acts as)
Input	I believe I shall---	no, I'm going to do it.	
Output	I believe I shall—	no, I'm going to do it.	
Comment	use —	when a thought evolves on the fly	

Emdashes should be used sparingly in formal writing.

figure dash The figure dash (input: `\FigureDash`) is used to separate digits—it's the same width as a digit and is used in identification numbers, part numbers, phone numbers, etc. Type, for example, `Q6759\FigureDash 18100` to get “Q6759-18100”.

minus sign Used for negative numbers or subtraction in math mode.

Input	Output	Comment
-	–	(one hyphen in text math mode or display math mode)
<code>\(-a + b\)</code>	$-a + b$	negative a
<code>\(a - b\)</code>	$a - b$	subtraction

2. DO NOT USE THESE PACKAGES

The `\usepackage{packagename}` command is used to load a package.

Do not use these packages for the listed purposes. Using them for these purposes is not compatible with `PurdueThesis`.

Name	For
<code>babel</code>	Translating “Table of Contents”, etc. to foreign languages. Reported by Danushka Menikkumbura. Send email to <code>latex@ecn.purdue.edu</code> if you need to typeset multiple languages in your thesis.
<code>caption</code>	Used to customize captions. Do not load this package, it is not compatible with <code>PurdueThesis</code> .
<code>subfig</code>	For subfigures. This package is deprecated. Do not load this package. See page 70 for how to do subfigures.
<code>subfigure</code>	For subfigures. This package is deprecated. Do not load this package. See page 70 for how to do subfigures.

3. SUMMARY

This is the summary chapter.

3.1 First Section

This is the first section of the summary chapter.

```
1 \chapter{SUMMARY}
2
3 This is the summary chapter.
4
5
6 \section{First Section}
7
8 This is the first section of the summary chapter.
```

4. RECOMMENDATIONS

Buy low. Sell high.

5. TEST ENVIRONMENTS AND PER-CHAPTER REFERENCES

`\cite[page v]{knuth2012}` gives “[1, page v]”.

`\cite[back cover]{lamport1994}` gives “[2, back cover]”.

`\cite{thesis2017}` gives “[3]”.

`\cite{thesis2020}` gives “[4]”.

This is an example of normal text. This is an example of normal text. This is an example of normal text. This is an example of normal text. This is an example of normal text. This is an example of normal text. This is an example of normal text. This is an example of normal text. This is an example of normal text. This is an example of normal text. This is an example of normal text.

Definition 5.0.1. This is an example definition. This is an example definition. This is an example definition. This is an example definition. This is an example definition.

This is an example of normal text. This is an example of normal text. This is an example of normal text. This is an example of normal text. This is an example of normal text. This is an example of normal text. This is an example of normal text. This is an example of normal text. This is an example of normal text. This is an example of normal text.

Observation 5.0.1. This is an example observation. This is an example observation. This is an example observation. This is an example observation. This is an example observation.

This is an example of normal text. This is an example of normal text. This is an example of normal text. This is an example of normal text. This is an example of normal text. This is an example of normal text. This is an example of normal text. This is an example of normal text. This is an example of normal text. This is an example of normal text.

Proof. This is an example proof. This is an example proof. This is an example proof. This is an example proof. If $a = b$ and $b = c$ then $a = c$. □

This is an example of normal text. This is an example of normal text. This is an example of normal text. This is an example of normal text. This is an example of normal text. This is an example of normal text. This is an example of normal text. This is an example of normal text. This is an example of normal text. This is an example of normal text.

Proposition 5.0.1. This is an example proposition. This is an example proposition. This is an example proposition. This is an example proposition. This is an example proposition. This is an example proposition.

This is an example of normal text. This is an example of normal text. This is an example of normal text. This is an example of normal text. This is an example of normal text. This is an example of normal text. This is an example of normal text. This is an example of normal text. This is an example of normal text. This is an example of normal text. This is an example of normal text.

Theorem 5.0.1. This is an example theorem. This is an example theorem. This is an example theorem. This is an example theorem. This is an example theorem. This is an example theorem.

This is an example of normal text. This is an example of normal text. This is an example of normal text. This is an example of normal text. This is an example of normal text. This is an example of normal text. This is an example of normal text. This is an example of normal text. This is an example of normal text. This is an example of normal text. This is an example of normal text.

References

- [1] D. E. Knuth, *The T_EXbook*. Addison-Wesley, ISBN: 978-0-201-13447-6.
- [2] L. Lamport, *L^AT_EX: A Document Preparation System*, 2nd ed. Reading Massachusetts: Addison-Wesley, 1994, ISBN: 0-201-52983-1.
- [3] Thesis and Dissertation Office, *A manual for the preparation of graduate theses*, The Graduate School, Purdue University, Aug. 30, 2017. [Online]. Available: <https://www.purdue.edu/gradschool/documents/thesis/graduate-thesis-manual.pdf>, Parts of this are out of date.
- [4] Thesis and Dissertation Office, The Graduate School, Purdue University, *Microsoft Word templates*, Feb. 17, 2020. [Online]. Available: <https://www.purdue.edu/gradschool/research/thesis/templates.html#accordian>.

REFERENCES

- [1] Wikipedia contributors, *Gasoline*, version 1024893259, May 24, 2021. [Online]. Available: <https://en.wikipedia.org/wiki/Gasoline>.
- [2] Wikipedia contributors, *Valvoline*, version 1020356743, Apr. 28, 2021. [Online]. Available: <https://en.wikipedia.org/wiki/Valvoline>.
- [3] Oxford English Dictionary. “Supercalifragilisticexpialidocious.” (Dec. 2020), [Online]. Available: <https://www.oed.com/view/Entry/194228>.
- [4] D. E. Knuth, *The T_EXbook*. Addison-Wesley, ISBN: 978-0-201-13447-6.
- [5] L. Lamport, *L^AT_EX: A Document Preparation System*, 2nd ed. Reading Massachusetts: Addison-Wesley, 1994, ISBN: 0-201-52983-1.
- [6] Overleaf, *Overleaf*, 2022. [Online]. Available: <https://www.overleaf.com>.
- [7] J. Collins, *Latexmk – generate L^AT_EX document*, version 4.77, Mar. 17, 2022. [Online]. Available: <https://mirror.mwt.me/ctan/support/latexmk/latexmk.pdf>.
- [8] Thesis and Dissertation Office. “Resources.” Click on “Menu”, then click on “RESOURCES”, and then click on “Formatting Guidelines and Deposit Procedures” or “TEMPLATES”. (2020), [Online]. Available: <https://www.purdue.edu/gradschool/research/thesis/>.
- [9] R. Sharpe, E. Warnicke, and U. Lamping, *Wireshark users’s guide*, version 3.3.0. [Online]. Available: https://www.wireshark.org/docs/wsug_html_chunked/PrefaceTypographicConventions.html.
- [10] L. E. van Dijk and C. L. Spiel. “Scilab bag of tricks: The scilab-2.5 iaq (infrequently asked questions).” (Jun. 4, 2000), [Online]. Available: <http://kiwi.emse.fr/SCILAB/sci-bot/sci-bot.pdf>.
- [11] T. Weh. “Menukeys–format menu sequences, paths and keystrokes from lists.” version 1.5. (Aug. 8, 2016), [Online]. Available: <http://www.ctan.org/pkg/menukeys>.

- [12] B. Yagoda, “The rise of “logical punctuation”,” *Slate*, May 12, 2011. [Online]. Available: <https://slate.com/human-interest/2011/05/logical-punctuation-should-we-start-placing-commas-outside-quotation-marks.html>.
- [13] Wikipedia contributors, *Hyphen*, version 1034109511, Jul. 17, 2021. [Online]. Available: <https://en.wikipedia.org/wiki/Hyphen>.
- [14] Wikipedia contributors, *En dash*, version 1055060523, Nov. 13, 2021. [Online]. Available: https://en.wikipedia.org/wiki/Dash#En_dash.
- [15] Wikipedia contributors, *Em dash*, version 1055060523, Nov. 13, 2021. [Online]. Available: https://en.wikipedia.org/wiki/Dash#Em_dash.
- [16] The Chicago Manual of Style. “All-numeral dates and other brief forms.” Section 9.35. (2017), [Online]. Available: <https://www-chicagomanualofstyle-org.ezproxy.lib.purdue.edu/book/ed17/part2/ch09/psec035.html>.
- [17] The Chicago Manual of Style. “ISO style for dates.” Section 9.36. (2017), [Online]. Available: <https://www-chicagomanualofstyle-org.ezproxy.lib.purdue.edu/book/ed17/part2/ch09/psec036.html>.
- [18] M. Goossens, F. Mittelbach, and A. Samarin, *The L^AT_EX Companion*. Reading Massachusetts: Addison-Wesley, 1994.
- [19] H. Kopka and P. W. Daly, *A Guide to L^AT_EX: Document Preparation for Beginners and Advanced Users*, 3rd ed. Reading Massachusetts: Addison-Wesley, 1999.
- [20] H. Kopka and P. W. Daly, *A Guide to L^AT_EX: Document Preparation for Beginners and Advanced Users*, 2nd ed. Reading Massachusetts: Addison-Wesley, 1995.
- [21] A. Anteater, B. Bear, C. Cheetah, D. Deer, and E. Eagle, *An imaginary document not about Mark Senn or NASA*, M. Senn, Ed., version 1.0, Imaginaryville, Indiana, Oct. 27, 2020. DOI: 00.0000/000-0-000-00000-0. [Online]. Available: <https://bogus.com/bogus.html>.
- [22] K. Hambleton, Ed., *Deep Space Gateway to Open Opportunities for Distant Destinations*, NASA, Aug. 24, 2018. [Online]. Available: <https://www.nasa.gov/feature/deep-space-gateway-to-open-opportunities-for-distant-destinations>.
- [23] W. H. Gerstenmaier, *Progress in Defining the Deep Space Gateway and Transport Plan*, https://www.nasa.gov/sites/default/files/atoms/files/nss_chart_v23.pdf, NASA, Mar. 2017.

- [24] W. H. Gerstenmaier, *Progress in Defining the Deep Space Gateway and Transport Plan*, NASA, Mar. 28, 2017. [Online]. Available: https://www.nasa.gov/sites/default/files/atoms/files/nss_chart_v23.pdf.
- [25] D. K. Farkas, *Managing headings in print and online documents*, 2011. [Online]. Available: <https://faculty.washington.edu/farkas/TC510-Fall2011/Farkas-ManagingHeadings.pdf>.
- [26] MathWorks Help Center. “Text properties.” version R2021b. (2022), [Online]. Available: https://www.mathworks.com/help/matlab/ref/matlab.graphics.primitive.text-properties.html#budt_bq-1_sep_shared-Interpreter.
- [27] T. G. Kristensen, *Example: Yin and yang*, Feb. 19, 2008. [Online]. Available: <https://texample.net/tikz/examples/all/yin-and-yang>.
- [28] P. O. W. Lab. “Ieee reference list.” (), [Online]. Available: https://owl.purdue.edu/owl/research_and_citation/ieee_style/reference_list.html.
- [29] IEEEDataPort. “How too cite references: Ieee documentation style.” (), [Online]. Available: <https://iee-dataport.org/sites/default/files/analysis/27/IEEE%20Citation%20Guidelines.pdf>.
- [30] P. Erds, “Diameters of point sets,” *Geombinatorics*, vol. 1, no. 4, p. 4, 1992. [Online]. Available: <https://www.oakland.edu/Assets/upload/docs/Erdos-Number-Project/erdpubs.2010.pdf>.
- [31] Wikipedia contributors, *Bushel*, version 1020154300, Apr. 27, 2021. [Online]. Available: <https://en.wikipedia.org/wiki/Bushel>.
- [32] S. Kottwitz, *L^AT_EX Beginner’s Guide*, 2nd ed. Packt Publishing Ltd., Aug. 2021. [Online]. Available: <https://learning.oreilly.com/library/view/latex-beginners-guide/9781801078658/cover.xhtml>.
- [33] IEEE, “IEEE author center,” 2021. [Online]. Available: <https://journals.ieeeauthorcenter.ieee.org/your-role-in-article-production/ieee-editorial-style-manual/>.
- [34] IEEE, “IEEE editorial style manual for authors,” Aug. 19, 2020. [Online]. Available: http://journals.ieeeauthorcenter.ieee.org/wp-content/uploads/sites/7/IEEE-Editorial-Style-Manual_081920.pdf.

- [35] IEEE, “Editing mathematics,” Nov. 12, 2018. [Online]. Available: <http://journals.ieeeauthorcenter.ieee.org/wp-content/uploads/sites/7/Editing-Mathematics.pdf>.
- [36] IEEE, “IEEE reference guide,” Jan. 29, 2021. [Online]. Available: <http://journals.ieeeauthorcenter.ieee.org/wp-content/uploads/sites/7/IEEE-Reference-Guide-Online-v.04-20-2021.pdf>.
- [37] Stack Exchange contributors, *T_EX - L^AT_EX stack exchange*, 2022. [Online]. Available: <https://tex.stackexchange.com>.
- [38] H. Voss, *Typesetting tables with L^AT_EX*. Cambridge, England: UIT Cambridge Ltd., 2011. [Online]. Available: <https://www.uit.co.uk/computing/typesetting-mathematics-with-latex>.
- [39] M. Senn, *This is the t001 title*. Feb. 12, 2019.
- [40] M. Senn, *This is the t010 title*. Feb. 12, 2019.
- [41] M. Senn, *This is the t002 title*. Feb. 12, 2019.
- [42] M. Senn, *This is the t003 title*. Feb. 12, 2019.
- [43] M. Senn, *This is the t004 title*. Feb. 12, 2019.
- [44] M. Senn, *This is the t005 title*. Feb. 12, 2019.
- [45] M. Senn, *This is the t006 title*. Feb. 12, 2019.
- [46] M. Senn, *This is the t007 title*. Feb. 12, 2019.
- [47] M. Senn, *This is the t008 title*. Feb. 12, 2019.
- [48] M. Senn, *This is the t009 title*. Feb. 12, 2019.
- [49] M. Senn, *This is the t011 title*. Feb. 12, 2019.
- [50] M. Senn, *This is the t020 title*. Feb. 12, 2019.
- [51] M. Senn, *This is the t012 title*. Feb. 12, 2019.
- [52] M. Senn, *This is the t013 title*. Feb. 12, 2019.
- [53] M. Senn, *This is the t014 title*. Feb. 12, 2019.
- [54] M. Senn, *This is the t015 title*. Feb. 12, 2019.
- [55] M. Senn, *This is the t016 title*. Feb. 12, 2019.
- [56] M. Senn, *This is the t017 title*. Feb. 12, 2019.
- [57] M. Senn, *This is the t018 title*. Feb. 12, 2019.
- [58] M. Senn, *This is the t019 title*. Feb. 12, 2019.
- [59] M. Senn, *This is the t021 title*. Feb. 12, 2019.

- [60] M. Senn, *This is the t030 title*. Feb. 12, 2020.
- [61] M. Senn, *This is the t022 title*. Feb. 12, 2019.
- [62] M. Senn, *This is the t023 title*. Feb. 12, 2019.
- [63] M. Senn, *This is the t024 title*. Feb. 12, 2019.
- [64] M. Senn, *This is the t025 title*. Feb. 12, 2019.
- [65] M. Senn, *This is the t026 title*. Feb. 12, 2020.
- [66] M. Senn, *This is the t027 title*. Feb. 12, 2020.
- [67] M. Senn, *This is the t028 title*. Feb. 12, 2020.
- [68] M. Senn, *This is the t029 title*. Feb. 12, 2020.
- [69] M. Senn, *This is the t031 title*. Feb. 12, 2020.
- [70] M. Senn, *This is the t040 title*. Feb. 12, 2020.
- [71] M. Senn, *This is the t032 title*. Feb. 12, 2020.
- [72] M. Senn, *This is the t033 title*. Feb. 12, 2020.
- [73] M. Senn, *This is the t034 title*. Feb. 12, 2020.
- [74] M. Senn, *This is the t035 title*. Feb. 12, 2020.
- [75] M. Senn, *This is the t036 title*. Feb. 12, 2020.
- [76] M. Senn, *This is the t037 title*. Feb. 12, 2020.
- [77] M. Senn, *This is the t038 title*. Feb. 12, 2020.
- [78] M. Senn, *This is the t039 title*. Feb. 12, 2020.
- [79] M. Senn, *This is the t041 title*. Feb. 12, 2020.
- [80] M. Senn, *This is the t050 title*. Feb. 12, 2020.
- [81] M. Senn, *This is the t042 title*. Feb. 12, 2020.
- [82] M. Senn, *This is the t043 title*. Feb. 12, 2020.
- [83] M. Senn, *This is the t044 title*. Feb. 12, 2020.
- [84] M. Senn, *This is the t045 title*. Feb. 12, 2020.
- [85] M. Senn, *This is the t046 title*. Feb. 12, 2020.
- [86] M. Senn, *This is the t047 title*. Feb. 12, 2020.
- [87] M. Senn, *This is the t048 title*. Feb. 12, 2020.
- [88] M. Senn, *This is the t049 title*. Feb. 12, 2020.

- [89] M. Senn, *This is the t051 title*. Feb. 12, 2021.
- [90] M. Senn, *This is the t060 title*. Feb. 12, 2021.

- [91] M. Senn, *This is the t052 title*. Feb. 12, 2021.
- [92] M. Senn, *This is the t053 title*. Feb. 12, 2021.
- [93] M. Senn, *This is the t054 title*. Feb. 12, 2021.
- [94] M. Senn, *This is the t055 title*. Feb. 12, 2021.
- [95] M. Senn, *This is the t056 title*. Feb. 12, 2021.
- [96] M. Senn, *This is the t057 title*. Feb. 12, 2021.
- [97] M. Senn, *This is the t058 title*. Feb. 12, 2021.
- [98] M. Senn, *This is the t059 title*. Feb. 12, 2021.
- [99] M. Senn, *This is the t061 title*. Feb. 12, 2021.
- [100] M. Senn, *This is the t070 title*. Feb. 12, 2021.
- [101] M. Senn, *This is the t062 title*. Feb. 12, 2021.
- [102] M. Senn, *This is the t063 title*. Feb. 12, 2021.
- [103] M. Senn, *This is the t064 title*. Feb. 12, 2021.
- [104] M. Senn, *This is the t065 title*. Feb. 12, 2021.
- [105] M. Senn, *This is the t066 title*. Feb. 12, 2021.
- [106] M. Senn, *This is the t067 title*. Feb. 12, 2021.
- [107] M. Senn, *This is the t068 title*. Feb. 12, 2021.
- [108] M. Senn, *This is the t069 title*. Feb. 12, 2021.
- [109] M. Senn, *This is the t071 title*. Feb. 12, 2021.
- [110] M. Senn, *This is the t080 title*. Feb. 12, 2022.
- [111] M. Senn, *This is the t072 title*. Feb. 12, 2021.
- [112] M. Senn, *This is the t073 title*. Feb. 12, 2021.
- [113] M. Senn, *This is the t074 title*. Feb. 12, 2021.
- [114] M. Senn, *This is the t075 title*. Feb. 12, 2021.
- [115] M. Senn, *This is the t076 title*. Feb. 12, 2022.
- [116] M. Senn, *This is the t077 title*. Feb. 12, 2022.
- [117] M. Senn, *This is the t078 title*. Feb. 12, 2022.
- [118] M. Senn, *This is the t079 title*. Feb. 12, 2022.
- [119] M. Senn, *This is the t081 title*. Feb. 12, 2022.
- [120] M. Senn, *This is the t090 title*. Feb. 12, 2022.
- [121] M. Senn, *This is the t082 title*. Feb. 12, 2022.
- [122] M. Senn, *This is the t083 title*. Feb. 12, 2022.

- [140] M. FRANZ, *The soul package*, version v2.19, Nov. 17, 2003. [Online]. Available: <https://mirrors.mit.edu/CTAN/macros/generic/soul/soul.pdf>.
- [141] D. U. Kern, *Extending latex color facilities: The xcolor package*, version v2.13, Oct. 31, 2021. [Online]. Available: <https://ctan.math.illinois.edu/macros/latex/contrib/xcolor/xcolor.pdf>.
- [142] Meriam-Webster, *Irregardless*. Merriam-Webster, 2022. [Online]. Available: <https://www.merriam-webster.com/dictionary/irregardless>.
- [143] Meriam-Webster, *out of date / out-of-date*. Merriam-Webster, 2022. [Online]. Available: <https://www.merriam-webster.com/dictionary/out-of-date>.
- [144] TheWriter, *To hyphenate or not to hyphenate?* The Writer. [Online]. Available: <http://www.thewriter.com/what-we-think/style-guide/to-hyphenate-or-not-to-hyphenate>.
- [145] Oxford English Dictionary, *out of date*. Oxford University Press, 2020. [Online]. Available: <https://www.oed.com/view/Entry/133785?redirectedFrom=out+of+date>.
- [146] Meriam-Webster, *Deprecate*. Jan. 18, 2022. [Online]. Available: <https://www.merriam-webster.com/dictionary/deprecated>.
- [147] Wikipedia contributors, *Startup company*, version 1013151991, Jan. 27, 2022. [Online]. Available: https://en.wikipedia.org/w/index.php?title=Startup_company.
- [148] W. Rader, Ed., *peace out*. The Online Slang Dictionary, 2020. [Online]. Available: <http://onlineslangdictionary.com/search/?q=peace+out&sa=Search>.
- [149] E. A. Feffin, *The chemplants package*, version 0.9.8, Nov. 19, 2019. [Online]. Available: <https://ctan.math.illinois.edu/graphics/pgf/contrib/chemplants/chemplants-doc.pdf>.
- [150] M. Hensel, *The mhchem bundle*, Jun. 22, 2018. [Online]. Available: <https://ctan.org/pkg/mhchem?lang=en>.
- [151] R. Meerman, *The mathematics of weight loss*, Oct. 10, 2013. [Online]. Available: <https://www.youtube.com/watch?v=vuIlsN32WaE>.
- [152] C. Tellechea, *Chemfig: A T_EX package for drawing molecules*, version 1.6a, Feb. 28, 2021. [Online]. Available: <https://ctan.org/pkg/chemfig?lang=en>.

- [153] A. Mittelbach, *Cryptocode - Typesetting Cryptography*, version 0.44, Aug. 15, 2021. [Online]. Available: <https://ctan.math.washington.edu/tex-archive/macros/latex/contrib/cryptocode/cryptocode.pdf>.
- [154] R. Jaramillo, *Example: 18W MOSFET amplifier with npn transistor*, May 11, 2014. [Online]. Available: <https://texample.net/tikz/examples/mosfet>.
- [155] M. A. Redaelli, S. Lindner, S. Erhard, and R. Giannetti, *CircuitikZ - draw electrical networks with TikZ*, version 1.3.7, Jun. 1, 2021. [Online]. Available: <https://www.ctan.org/pkg/circuitikz>.
- [156] B. Lingner, *Kalman filter system model*, Apr. 21, 2010. [Online]. Available: <https://texample.net/tikz/examples/kalman-filter/>.
- [157] Wikipedia contributors, *L^AT_EX/linguistics*, version 3775673, Nov. 29, 2020. [Online]. Available: <https://en.wikibooks.org/w/index.php?title=LaTeX/Linguistics&oldid=3775673>.
- [158] N. V. Tambe, *Doulossil — a font for typesetting the international phonetic alphabet (ipa)*, version 0.1, Sep. 21, 2020. [Online]. Available: <https://www.ctan.org/pkg/doulossil>.
- [159] M. A. Covington and Jürgen Spitzmüller. “The covington package macros for linguistics.” version 2.7, September 1, 2021. (Sep. 1, 2021), [Online]. Available: <https://ctan.org/pkg/covington/covington.pdf>.
- [160] American Mathematical Society, L^AT_EX3 Project, *User’s guide for the AMSmath package*, version 2.1, Oct. 14, 2019. [Online]. Available: <http://mirrors.ctan.org/info/amslatex/english/amslatex/amsldoc.pdf>.
- [161] G. Grätzer, *More Math Into L^AT_EX*, 5th ed. Springer International Publishing, Feb. 23, 2016, p. 41, ISBN: 978-3-319-23796-1. DOI: [10.1007/978-3-319-23796-1](https://doi.org/10.1007/978-3-319-23796-1).
- [162] American Mathematical Society, L^AT_EX3 Project, *User’s guide for the AMSmath package*, version 2.1, Oct. 14, 2019. [Online]. Available: <https://ctan.org/tex-archive/info/amslatex/english?lang=en>.
- [163] B. Greene, *For #PiDay, one of the coolest formulae for today’s honoree*, Mar. 14, 2021. [Online]. Available: <https://twitter.com/bgreene/status/1371234232304082944>.

- [164] ISO/TC 12 Committee, *ISO 80000-2:2019 Quantities and units — part 2: Mathematics*, Aug. 2019. [Online]. Available: <https://www.iso.org/standard/64973.html>.
- [165] M. Reid. “Jerk, jounce, snap, crackle and pop.” (Dec. 11, 2013), [Online]. Available: <http://wordpress.mrreid.org/2013/12/11/jerk-jounce-snap-crackle-and-pop/>.
- [166] Khan Academy, *Quadratic formula proof review*, 2018. [Online]. Available: <https://www.khanacademy.org/math/algebra/quadratics/solving-quadratics-using-the-quadratic-formula/a/quadratic-formula-proof-review>.
- [167] Lumen Learning. “Bayes’ theorem.” (), [Online]. Available: <https://courses.lumenlearning.com/mathforliberalartscorequisite/chapter/bayes-theorem>.
- [168] Wikipedia contributors, *Squared triangular number*, version 1068580286, Jan. 29, 2022. [Online]. Available: https://en.wikipedia.org/w/index.php?title=Squared_triangular_number&oldid=1068580286.
- [169] H. Li, *Latex capabilities: Complicated and important equations*, Feb. 20, 2013. [Online]. Available: <https://tex.stackexchange.com/questions/99038/latex-capabilities-complicated-and-important-equations>.
- [170] B. Greene, *Quantum mechanics in a nutshell*, Apr. 4, 2021. [Online]. Available: <https://twitter.com/bgreene/status/1378902329609613312>.
- [171] yourlazyphysicist, *Question in String Theory / Mass of States / Number Operator*, Nov. 30, 2017. [Online]. Available: <https://math.stackexchange.com/questions/2544829/question-in-string-theory-mass-of-states-number-operator>.
- [172] Wikipedia contributors, *Lilypond*, version 1031722352, Jan. 16, 2022. [Online]. Available: <https://en.wikipedia.org/w/index.php?title=LilyPond&oldid=1065994922>.
- [173] Thesis and Dissertation Office, *Template-One.docx Microsoft Word thesis template*, The Graduate School, Purdue University, 2020. [Online]. Available: <https://purdue.edu/gradschool/documents/thesis/Template-One.docx>.
- [174] Thesis and Dissertation Office, *Template-Two.docx Microsoft Word thesis template*, The Graduate School, Purdue University, 2020. [Online]. Available: <https://purdue.edu/gradschool/documents/thesis/Template-Two.docx>.
- [175] Thesis and Dissertation Office, *Template-Three.docx Microsoft Word thesis template*, The Graduate School, Purdue University, 2020. [Online]. Available: <https://purdue.edu/gradschool/documents/thesis/Template-Three.docx>.

A. ABOUT THE APPENDICES

These appendices are single-spaced to save space. Your thesis should use the default 1.5 line spacing.

There are two groups of appendices. The first group are general appendices; the second group are domain-specific appendices.

These appendices are a series of examples. They are a work in progress.

Each example consists of some \LaTeX output followed by the corresponding input lines. Some \LaTeX input lines only define things and don't produce any output. Each chunk in the input file begins with `\begin{VerbatimOut}{z.out}` then has the \LaTeX input for the example, and ends with `\end{VerbatimOut}`, followed by a blank line, followed by a line that begins with `\My`.

```
1 \chapter{ABOUT THE APPENDICES}
2
3 % Use single spacing in the appendices from now on to save space.
4 \ZZbaselinestretch{1}
5
6 \textcolor{red}{%
7 \textbf{%
8     These appendices are single-spaced to save space.
9     Your thesis should use the default-1.5 line spacing.%
10 }}%
11 }
12
13 There are two groups of appendices.
14 The first group are general appendices;
15 the second group are domain-specific appendices.
16
17 These appendices are a series of examples.
18 They are a work in progress.
19
20 Each example consists of some  $\LaTeX$  output
21 followed by the corresponding input lines.
22 Some  $\LaTeX$  input lines only define things
23 and don't produce any output.
24 Each chunk in the input file begins with
25 \verb+\begin{VerbatimOut}{z.out}+
26 then has the  $\LaTeX$  input for the example,
27 % Don't literally end VerbatimOut on next line.
28 and ends with {\tt \char'134 end\char'173 VerbatimOut\char'175},
29 followed by a blank line,
30 followed by a line that begins with
31 \My.
32
```

A.1 Paragraphs

This is the first paragraph. Paragraphs are separated by blank lines.

This is the second paragraph.

A.2 Section Heading

This is a sentence. This is a sentence. This is a sentence. This is a sentence. This is a sentence.

A.2.1 Subsection heading

This is a sentence. This is a sentence. This is a sentence. This is a sentence. This is a sentence.

Subsubsection heading

This is a sentence. This is a sentence. This is a sentence. This is a sentence. This is a sentence.

```
1
2
3 \section{Paragraphs}
4
5 This is the first paragraph.
6 Paragraphs are separated by blank lines.
7
8 This is the second paragraph.
9
10
11 \section{Section Heading}
12
13 This is a sentence.
14 This is a sentence.
15 This is a sentence.
16 This is a sentence.
17 This is a sentence.
18
19
20 \subsection{Subsection heading}
21
22 This is a sentence.
23 This is a sentence.
24 This is a sentence.
25 This is a sentence.
26 This is a sentence.
27
28
29 \subsubsection{Subsubsection heading}
30
31 This is a sentence.
32 This is a sentence.
33 This is a sentence.
34 This is a sentence.
35 This is a sentence.
```

A.3 Text math

If items in a list are narrow like these Greek characters,

α , β , and γ

I'd input the line like this

α , β , and γ

where the \sim is a tie that ties together what's before and after it on the same line of the output [4, page 92].

This text is the correct length to show what happens with and without ties: α , β , and γ . See how the line gets split and the γ is at the beginning of the line?

This text is the correct length to show what happens with and without ties: α , β , and γ . See how the line gets compressed a little bit so the γ is not at the beginning of the line?

```
1
2
3 \section{Text math}
4
5 If items in a list are narrow like these Greek characters,\
6 \I2 \verb+\alpha$, \beta$, and \gamma$+\
7 I'd input the line like this\
8 \I2 \verb+\alpha$,~\beta$, and~\gamma$+\
9 where the \verb+~+ is a tie
10 that ties together what's before and after it on the same line of the output
11 \cite[page~92]{knuth2012}.
12
13 This text is the correct length to show what happens with and without ties:
14 \alpha$,
15 \beta$,
16 and \gamma$.
17 See how the line gets split
18 and the~\gamma$ is at the beginning of the line?
19
20 This text is the correct length to show what happens with and without ties:
21 \alpha$,~\beta$,
22 and~\gamma$.
23 See how the line gets compressed a little bit so the~\gamma$
24 is not at the beginning of the line?
```

B. BUGS

This appendix lists all bugs/comments/issues/etc. under the generic name ‘bug’. Each bug is assigned a number when I learn of it. Bug numbers are 1, 2, I started keeping track of bugs in this fashion on February 26, 2022, and some previously known bugs are included in this list. A color indicates a bug’s priority:

Description	Color
done or waiting on someone else	black
high priority or easy to do	red
low priority	green
not prioritized yet	gray

See the `ap-bugs.tex` file for the L^AT_EX input for this appendix.

B.1 These bugs need to be looked at

BUG 1. Table of Contents is double-spaced instead of 1½ spacing. Tighten up section and less significant headings spacing? Reported by Anita Adams Sale on 2021-03-17.

BUG 2. List of Figures indented $\approx 1/4$ inch more than List of Tables. Reported by Anita Adams Sale on 2021-03-17. Still happening on 2021-11-30. Looked ok on 2022-08-26 but I think this problem is probably intermittent. Keep Ashlee Messersmith, Anita Adams Sale, and Sherrie Tucker informed.

BUG 6. APA reference style indents references too far on left. Reported by Mark Senn on 2021-04-08.

BUG 8. Use “Last Accessed: yyyy-mm-dd.” `urldate` in bibliography. Reported by Mark Senn on 2021-04-19.

BUG 9. Check that `@{}` is before the left column and after the right column in all tables. Reported by Mark Senn on 2021-04-19.

BUG 11. Bibliography change: Change, for example, “Acoustical Science and Technology, vol. 23, no. 1” to “Acoustical Science and Technology **23 (1)**”. Reported by Daniel Joesph Carr on 2021-06-16.

BUG 12. Bibliography change: Change, for example, `M.~Abramowitz and I.A.~Stegun, Eds.,` to `M.~Abramowitz and I.A.~Stegun, editors,.` Reported by Daniel Joesph Carr on 2021-06-16.

BUG 13. Headings containing a SmallCaps font do not work. Reported by Javad (Nima) Darivandpour on 2021-06-29. See [R.5](#).

BUG 14. On Overleaf only, when using `\def\ZZshowtimestamp{true}`, the time and sometimes the date are wrong at the top of the page. Reported by Mark Senn on 2022-02-25. This might be due to using `\ExplSyntaxOn ... \ExplSyntaxOff` and having `:` and/or other characters having the wrong catcode.

BUG 15. Left reference section margin is ok if a person has 10–99 references. Figure out how to adjusting margin for 1–9 or over 99 references. Reported by Mark Senn on unknown date.

BUG 19. Bibliography and References missing from navigation panel. Reported by Mark Senn on 2022-02-28. REFERENCES was in navigation panel on 2022-08-26.

BUG 20. Bibliography and References should be in all caps. Reported by Mark Senn on 2022-02-28. REFERENCES was in all caps on 2022-08-26.

BUG 21. IE students should be able to specify IEEE or APA bibliography format. Reported by Patrick Brunese on 2022-03-04.

B.2 These bugs are waiting on a reply from someone other than Mark Senn

BUG 10. Using `linktoc = section` does not work with captions with `\frac`. Reported by Mark Senn on 2021-05-27. In the short-term, check with Ashlee Messersmith if `linktoc = page` can be used. If that’s ok make the change and look into changing captions from my code to L^AT_EX’s code. Waiting on Ashlee Messersmith.

B.3 These bugs have been rejected or fixed

BUG 3. Use “Last Accessed: dd/mm/yy.” `urldate` in bibliography. Reported by Priyank Kalganekar on 2021-04-06. Answered by Mark Senn on 2022-02-27. The United States uses mm/dd/yy and other countries use dd/mm/yy [16]. I recommend using what your bibliography style defines or the unambiguous ISO 8601 standard yyyy-mm-dd [17].

BUG 4. Change citation, e.g., [6], [71] to [6,71]. Reported by Mark Senn on 2021-04-07. Fixed on 2022-04-14. Tested ok on 2022-04-14.

BUG 5. Change citation, e.g., [6], [7], [8] to [6–8]. Reported by Mark Senn on 2021-04-07. Fixed on 2022-04-14. Tested ok on 2022-04-14.

BUG 7. Non-nested description environments have bold items. Nested description environments have non-bold items. How come? Are the indentations correct? Reported by Mark Senn on 2021-04-09. Tested ok on 2021-05-31.

BUG 16. Add DTECH degree. Reported by Mark Senn on unknown date. Program “Technology” and degree “Doctor of Technology” worked ok on 2022-08-26.

BUG 17. Allow , (comma) in `\title`. Reported by Mark Senn on unknown date. Tested ok on 2021-11-30.

BUG 18. Allow `\\` in `\title`. Reported by Mark Senn on unknown date. Tested ok on 2021-11-30.

D. CHAPTER APPENDICES

Using `\chapterappendix` or `\chapterappendices` in a chapter will number sections, for example, 1.1, 1.2, ..., 1.A, 1.B,

Using `\chapterappendix` or `\chapterappendices` in an appendix will number sections, for example, A.1, A.2, ..., A.A, A.B,

I suggest only using `\chapterappendix` or `\chapterappendices` in chapters—using them in appendices is too confusing.

```
1 \chapter{CHAPTER APPENDICES}
2
3 Using |\chapterappendix|
4 or |\chapterappendices|
5 in a chapter will number sections,
6 for example,
7 1.1,
8 1.2,
9 \ldots,
10 1.A,
11 1.B,
12 \ldots\,.
13
14 Using |\chapterappendix|
15 or |\chapterappendices|
16 in an appendix will number sections,
17 for example,
18 A.1,
19 A.2,
20 \ldots,
21 A.A,
22 A.B,
23 \ldots\,.
24
25 I suggest only using |\chapterappendix|
26 or |\chapterappendices| in chapters---%
27 using them in appendices is too confusing.
```

D.1 This is a section heading

This is a paragraph.

Use `\chapterappendix` or `\chapterappendices` to make sections until the end of the next chapter be appendices.

D.A This is a chapter appendix

This is a paragraph.

```
1 \newpage
2
3
4 \section{This is a section heading}
5
6 This is a paragraph.
7
8 Use \verb+\chapterappendix+ or \verb+\chapterappendices+
9 to make sections until the end of the next chapter
10 be appendices.
11
12
13 \chapterappendix
14
15
16 \section{This is a chapter appendix}
17
18 This is a paragraph.
```

E. CITATIONS AND REFERENCES

```
1 \chapter{CITATIONS AND REFERENCES}
```

This chapter contains information about citations and references—how to cite a reference in the text and the fine points of defining a bibliography (also called “References”) entry.

```
1
2 This chapter contains information about citations
3 and references---how to cite a reference in the text
4 and the fine points of defining a bibliography
5 (also called ‘References’)
6 entry.
```

E.1 Citations

```
1
2
3 \section{Citations}
```

For L^AT_EX answers I refer to [5] and then to [18] or [19]. [19] is an update to [20].

```
1 For \LaTeX\ answers I refer to
2 \cite{lampport1994}
3 and then to
4 \cite{goossens1994}
5 or
6 \cite{kopka1999}.
7 \cite{kopka1999}
8 is an update to
9 \cite{kopka1995}.
```

Here is an example .bib file entry:

```
@misc{example2020,
  address   = {Imaginaryville, Indiana},
  author    = {Andrew Anteater and Bertha Bear and Charles Cheetah and Davida Deer
              and Ethan Eagle},
  date      = {2020-10-27},
  doi       = {00.0000/000-0-000-00000-0},
  editor     = {Mark Senn},
  edition   = {2},
  isbn      = {{000\FigureDash 0\FigureDash 000\FigureDash 00000\FigureDash 0}},
  publisher = {Bogus International Publishing Company},
  title     = {An Imaginary Document Not About {Mark Senn} or {NASA}},
  url       = {https://bogus.com/bogus.html},
  urldate   = {2020-10-27},
  version   = {1.0},
}
```

```
1
2 Here is an example .bib file entry:
3
4 {\footnotesize
5 \begin{verbatim}
6 @misc{example2020,
```

```

7   address = {Imaginaryville, Indiana},
8   author  = {Andrew Anteater and Bertha Bear and Charles Cheetah and Davida Deer
9             and Ethan Eagle},
10  date    = {2020-10-27},
11  doi     = {00.0000/000-0-000-00000-0},
12  editor  = {Mark Senn},
13  edition = {2},
14  isbn    = {{000\FigureDash 0\FigureDash 000\FigureDash 00000\FigureDash 0}},
15  publisher = {Bogus International Publishing Company},
16  title   = {An Imaginary Document Not About {Mark Senn} or {NASA}},
17  url     = {https://bogus.com/bogus.html},
18  urldate = {2020-10-27},
19  version = {1.0},
20 }
21 \end{verbatim}
22 }

```

PurdueThesis only uses Bib \LaTeX . Here are some example Bib \LaTeX citations for your document.

Input	Output
<code>\cite{example2020}</code>	[21]
<code>\cite*{example2020}</code>	[21]
<code>\citeauthor{example2020}</code>	Anteater, Bear, Cheetah, <i>et al.</i>
<code>\citeauthor*{example2020}</code>	Anteater <i>et al.</i>
<code>\citedate{example2020}</code>	Oct. 27, 2020
<code>\citetitle{example2020}</code>	<i>An Imaginary Document Not About Mark Senn or NASA</i>
<code>\citetitle*{example2020}</code>	<i>An Imaginary Document Not About Mark Senn or NASA</i>
<code>\citeurl{example2020}</code>	https://bogus.com/bogus.html
<code>\citeyear{example2020}</code>	2020
<code>\parencite{example2020}</code>	[21]
<code>\textcite{example2020}</code>	Anteater, Bear, Cheetah, <i>et al.</i> [21]

```

1 \PurdueThesisLogo\ only uses \BibLaTeXLogo.
2 Here are some example \BibLaTeXLogo\ citations for your document.
3
4 \begin{tabular}{@{}l@{}}
5   \bf Input& \bf Output\\
6   \verb+\cite{example2020}+& \cite{example2020}\\
7   \verb+\cite*{example2020}+& \cite*{example2020}\\
8   \verb+\citeauthor{example2020}+& \citeauthor{example2020}\\
9   \verb+\citeauthor*{example2020}+& \citeauthor*{example2020}\\
10  \verb+\citedate{example2020}+& \citedate{example2020}\\
11  \verb+\citetitle{example2020}+& \citetitle{example2020}\\
12  \verb+\citetitle*{example2020}+& \citetitle*{example2020}\\
13  \verb+\citeurl{example2020}+& \citeurl{example2020}\\
14  \verb+\citeyear{example2020}+& \citeyear{example2020}\\
15  \verb+\parencite{example2020}+& \parencite{example2020}\\
16  \verb+\textcite{example2020}+& \textcite{example2020}\\
17 \end{tabular}

```

E.2 References

```

1
2
3 \section{References}

```

Emily Spreen wrote that the following URLs are invisible in the PDF file. They worked fine for me on 2021-04-08. See [22], [23], and [24] in the REFERENCES.

```
@misc{hambleton,
  key = {Deep Space Gateway},
  title = {{Deep Space Gateway to Open Opportunities for Distant Destinations}},
  note = {Editor: Kathryn Hambleton},
  year = {2018},
  month = {August 24,},
  howpublished = {\url{https://www.nasa.gov/feature/deep-space-gateway-to-open-...}},
  organization = {NASA},
}
```

```
@misc{gerstenmaier,
  author = {William H. Gerstenmaier},
  title = {{Progress in Defining the Deep Space Gateway and Transport Plan}},
  month = {March},
  year = {2017},
  howpublished = {\url{https://www.nasa.gov/sites/default/files/atoms/files/...}},
  organization = {NASA},
}
```

I suggest using the following (added a ‘2’ to the key so they’d have separate entries in the references.).

```
@misc{gerstenmaier2,
  author = {William H. Gerstenmaier},
  date = {2017-03},
  title = {{Progress in Defining the Deep Space Gateway and Transport Plan}},
  url = {https://www.nasa.gov/sites/default/files/atoms/files/nss_chart_v23.pdf},
  organization = {NASA},
}
```

```
1
2 Emily Spreen wrote that the following URLs are invisible in the PDF file.
3 They worked fine for me on 2021-04-08.
4 See \cite{hambleton}, \cite{gerstenmaier}, and \cite{gerstenmaier2} in the REFERENCES.
```

```
5
6 {\footnotesize
7 \begin{verbatim}
8 @misc{hambleton,
9   key = {Deep Space Gateway},
10  title = {{Deep Space Gateway to Open Opportunities for Distant Destinations}},
11  note = {Editor: Kathryn Hambleton},
12  year = {2018},
13  month = {August 24,},
14  howpublished = {\url{https://www.nasa.gov/feature/deep-space-gateway-to-open-...}},
15  organization = {NASA},
16 }
17 \end{verbatim}
18 }
```

```
19
20 {\footnotesize
21 \begin{verbatim}
22 @misc{gerstenmaier,
23   author = {William H. Gerstenmaier},
24   title = {{Progress in Defining the Deep Space Gateway and Transport Plan}},
```

```

25     month = {March},
26     year = {2017},
27     howpublished = {\url{https://www.nasa.gov/sites/default/files/atoms/files/...}},
28     organization = {NASA},
29 }
30 \end{verbatim}
31 }
32
33 I suggest using the following
34 (added a '2' to the key so they'd have separate entries in the references.).
35 {\footnotesize
36 \begin{verbatim}
37 @misc{gerstenmaier2,
38     author = {William H. Gerstenmaier},
39     date = {2017-03},
40     title = {{Progress in Defining the Deep Space Gateway and Transport Plan}},
41     url = {https://www.nasa.gov/sites/default/files/atoms/files/nss_chart_v23.pdf},
42     organization = {NASA},
43 }
44 \end{verbatim}
45 }

```

F. COMMON MISTAKES

The following Headings, Mathematics, and Text sections describe some common mistakes.

F.1 Headings

Farkas [25, page 289] wrote

The practice of stacking headings is routinely condemned by style manuals and other authorities. Here is a typical statement, taken from Houghton Mifflin’s guidelines for authors.

Avoid “stacking” heads, or placing two levels of headings together without intervening text. A heading cannot substitute for the transitional or introductory paragraphs that guide the reader through a chapter. Remember too that a chapter opening looks better in type when one or more paragraphs of text precede the first heading.

```
1 \chapter{COMMON MISTAKES}
2
3 The following Headings, Mathematics, and Text
4 sections describe some common mistakes.
5
6
7 \section{Headings}
8
9 \textcite[page~289]{farkas2011}
10 wrote
11
12 \begin{quotation}
13 The practice of stacking headings
14 is routinely condemned by style manuals
15 and other authorities.
16 Here is a typical statement,
17 taken from Houghton Mifflin’s guidelines for authors.
18 \begin{quotation}
19 Avoid ‘‘stacking’’ heads,
20 or placing two levels
21 of headings together without intervening text.
22 A heading cannot substitute
23 for the transitional
24 or introductory paragraphs
25 that guide the reader through a chapter.
26 Remember too that a chapter opening looks better in type
27 when one
28 or more paragraphs
29 of text precede the first heading.
30 \end{quotation}
31 \end{quotation}
```

F.2 Mathematics

F.2.1 Put a little extra horizontal space before dx

```
1
2
```

```

3 \section{Mathematics}
4
5 \subsection{Put a little extra horizontal space before dx}

```

F.3 Text

```

1
2
3 \section{Text}

```

F.3.1 e.g.,

“e.g.” should always be followed by a comma.

```

1
2 \subsection{e.g.,}
3 \ix{e.g.}
4
5 ‘‘e.g.’’ should always be followed by a comma.

```

F.3.2 “et al.” is an abbreviation

The phrase “et al.” is an abbreviation and should always be followed by a period. It should be in the normal font for your document—do not italicize or underline it.

Example:

input	Thun et al.~used data from Santa Claus.
output	Thun et al. used data from Santa Claus.
comment	my recommendation
input	Thun et al. used data from Santa Claus.
output	Thun et al. used data from Santa Claus.
comment	too much space after period— \LaTeX thinks period is end of sentence
input	Thun et al\@. used data from Santa Claus.
output	Thun et al. used data from Santa Claus.
comment	spacing is right but the “et al.” could occur at end of a line

```

1
2 \subsection{‘‘et al.’’ is an abbreviation}
3 \ix{et al.}
4
5 The phrase ‘‘et al.’’
6 is an abbreviation
7 and should always be followed by a period.
8 It should be in the normal font for your document---%
9 do not italicize or underline it.
10
11 Example:\[6pt]
12 \indent\indent
13 \begin{tabular}{@{}l@{}}
14   input& \verb+Thun et al.~used data from Santa Claus.+\\
15   output& Thun et al.~used data from Santa Claus.\\

```

```

16  comment& my recommendation\\[6pt]
17  input&  \verb+Thun et al. used data from Santa Claus.+\\
18  output& Thun et al. used data from Santa Claus.\\
19  comment& too much space after period---\LaTeX\ thinks period is end of sentence\\[6pt]
20  input&  \verb+Thun et al\@. used data from Santa Claus.+\\
21  output& Thun et al\@. used data from Santa Claus.\\
22  comment& spacing is right but the ‘‘et al.’’ could occur at end of a line\\
23  \end{tabular}

```

F.3.3 i.e.,

“i.e.” should always be followed by a comma.

```

1
2  \subsection{i.e.,}
3  \ix{i.e.}
4
5  ‘‘i.e.’’ should always be followed by a comma.

```

G. DEFINING COMMANDS

The next paragraph demonstrates how to define and use a command.

Editors recommend that a chapter title should never be followed by a section heading without some intervening text. I suggest writing for readers. Break the rules if necessary.

```
1 \chapter{DEFINING COMMANDS}
2
3 The next paragraph demonstrates how to define and use a command.
4
5 \renewcommand{\t}[2]
6 {% The "{" hides the space caused by the newline. LaTeX ignores leading spaces on a line.
7 Editors recommend that a #1 should never be
8 followed by a #2 without some intervening text.
9 }
10
11 \t{chapter title}{section heading}
12 I suggest writing for readers.
13 Break the rules if necessary.
```

H. FIGURES

```
1 \chapter{FIGURES}
```

The `h` specifier used in all the examples below tells \LaTeX to put the figure “here” instead of trying to find a good spot at the top or bottom of a page. Specifiers can be combined, for example, “`\begin{figure}[htbp!]`”.

```
1
2 The
3 \verb+h+
4 specifier used in all the examples below
5 tells \LaTeX\ to put the figure
6 ‘‘here’’
7 instead of trying
8 to find a good spot
9 at the top or bottom of a page.
10 Specifiers can be combined,
11 for example,
12 ‘‘\verb+\begin{figure}[htbp!]+’’.
```

The complete list of figure placement specifiers:

Specifier	Description
<code>b</code>	bottom of page
<code>h</code>	here on page
<code>p</code>	on separate page of figures
<code>t</code>	top of page
<code>!</code>	try hard to put figure as early as possible

```
1
2 The complete list of figure placement specifiers:
3 \vspace*{6pt}
4 \begin{center}
5 \begin{tabular}{@{}ll@{}}
6 \toprule
7 \bf Specifier& \bf Description\\
8 \midrule
9 \noalign{\vspace*{2pt}}
10 \tt b& bottom of page\\
11 \tt h& here on page\\
12 \tt p& on separate page of figures\\
13 \tt t& top of page\\
14 \tt !& try hard to put figure as early as possible\\
15 \bottomrule
16 \end{tabular}
17 \end{center}
18 \index{figure!placement specifiers (\verb+b+, \verb+h+, \verb+p+, \verb+t+, {\tt \char'041})}
19 \index{\verb+\begin{tabular}+}
```

This is the first paragraph. This is the first paragraph. This is the first paragraph. This is the first paragraph. This is the first paragraph.

```
1
2 % MyRepeat is defined in MyRepeat.sty.
3 \MyRepeat{This is the first paragraph. }{5}
```

This is the figure.

Figure H.1. Allocation to Common Edge for $p(x_i) = 1 - e^{-x_i z}$

```

1
2 \begin{figure}
3   This is the figure.
4   \caption{%
5     Allocation to Common Edge for
6     \langle p(x_i) = 1 - e^{-x_i z} \rangle \frac{-x_i z}{\langle x_i \rangle}
7   }
8 \end{figure}

```

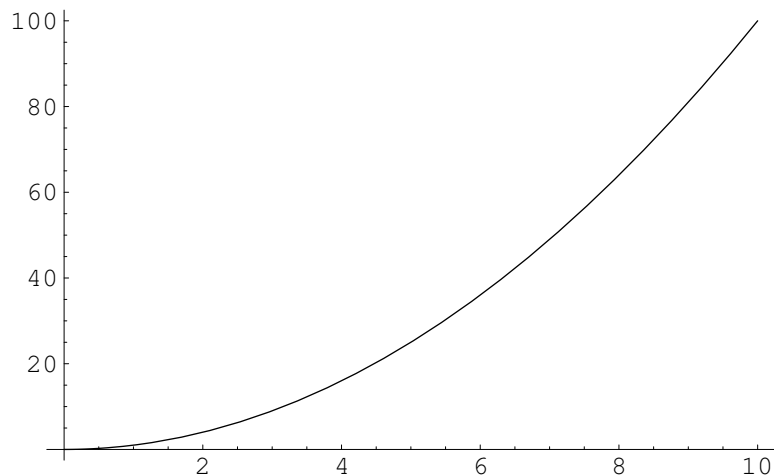

Figure H.2. By default figures are not centered. This is a long caption to demonstrate that captions are single spaced. This is a long caption to demonstrate that captions are single spaced.

```

1
2 \begin{figure}[ht]
3   \includegraphics{gr-plot.pdf}
4   \caption
5   {%
6     By default figures are not centered.
7     This is a long caption to demonstrate that captions are single spaced.
8     This is a long caption to demonstrate that captions are single spaced.%
9   }
10  \label{fi:not-centered}
11 \end{figure}

```

This is the second paragraph. This is the second paragraph. This is the second paragraph. This is the second paragraph. This is the second paragraph. This is the second paragraph. This is the second paragraph. This is the second paragraph.

```

1
2 \MyRepeat{This is the second paragraph. }{10}

```

```

1
2 \begin{figure}[ht]
3   \centering
4   \includegraphics{gr-plot.pdf}
5   \caption{Use {\tt \char'134centering\} to center figures.}
6   \label{fi:centered}
7 \end{figure}

```

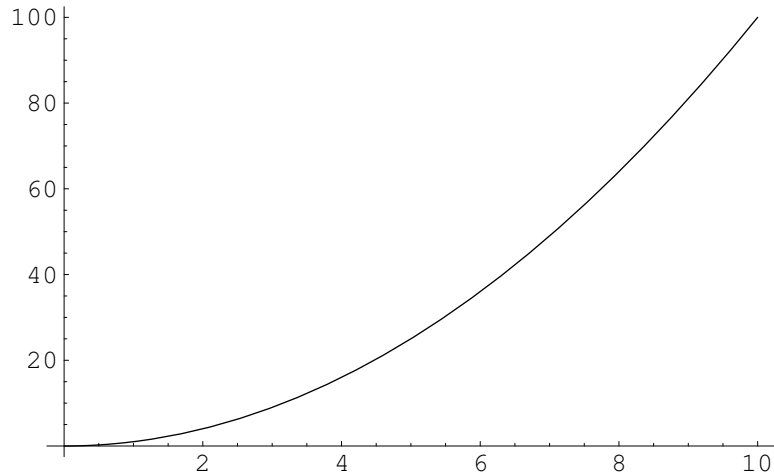

Figure H.3. Use `\centering` to center figures.

This is the third paragraph. This is the third paragraph. This is the third paragraph. This is the third paragraph. This is the third paragraph. This is the third paragraph. This is the third paragraph. This is the third paragraph. This is the third paragraph. This is the third paragraph. This is the third paragraph. This is the third paragraph. This is the third paragraph. This is the third paragraph. This is the third paragraph. This is the third paragraph. This is the third paragraph.

```

1
2 \MyRepeat{This is the third paragraph. }{15}

```

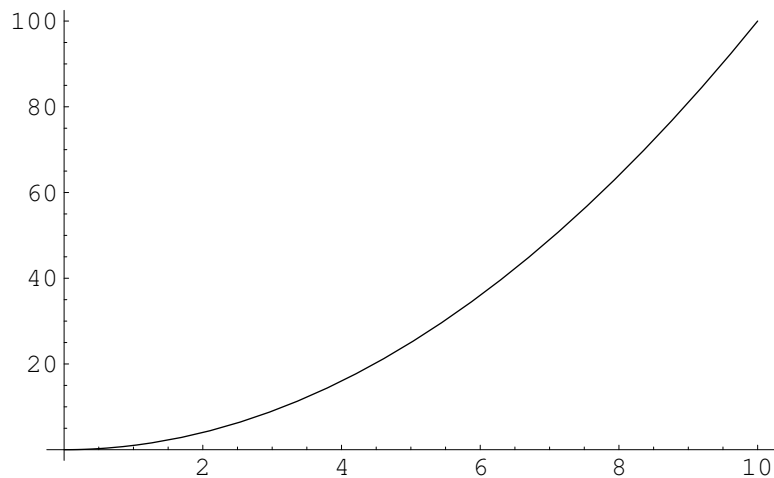

Figure H.4. This is another figure.

```

1
2 \begin{figure}[ht]

```

```

3 \centering
4 \includegraphics{gr-plot.pdf}
5 \caption{This is another figure.}
6 \label{fi:another}
7 \end{figure}

```

This is the fourth paragraph. This is the fourth paragraph. This is the fourth paragraph. This is the fourth paragraph. This is the fourth paragraph. This is the fourth paragraph. This is the fourth paragraph. This is the fourth paragraph. This is the fourth paragraph.

```

1
2 \MyRepeat{This is the fourth paragraph. }{10}

```

First subfigure.	Second subfigure.
(a) First subcaption.	(b) Second subcaption.

Figure H.5. This figure has two subfigures arranged horizontally.

```

1
2 % See pages 4--5 of
3 % http://mirrors.ibiblio.org/CTAN/macros/latex/contrib/caption/subcaption.pdf
4 % for how to use \subcaptionbox.
5 \begin{figure}[ht]
6 % Center the entire figure (containing the two subfigures).
7 \centering
8 % The \subcaptionbox for the first subfigure.
9 \subcaptionbox
10 % The first subcaption with a \label.
11 % Use \ref{sf:two-parts-a} to print the subcaption number.
12 {First subcaption.\label{sf:two-parts-a}}%
13 % The first subfigure is this wide.
14 [2in]%
15 % This is the first subfigure.
16 % You'll usually use an \includegraphics{filename}
17 % inside the braces on the next line.
18 {\bfseries First subfigure.}%
19 % Put 0.5 inches of blank space between the subfigures.
20 \hskip 0.5truein
21 \subcaptionbox
22 {Second subcaption.\label{sf:two-parts-b}}%
23 [2in]%
24 {\bfseries Second subfigure.}%
25 % The caption for the entire figure (containing two subfigures).
26 \caption{This figure has two subfigures arranged horizontally.}
27 % The label for the entire figure.
28 \label{fi:two-horizontal-parts}
29 \end{figure}
30 \ix{figure!subfigures!{\(\text{1 row} \times \text{2 columns}\)}}

```

This is the fifth paragraph. This is the fifth paragraph. This is the fifth paragraph. This is the fifth paragraph. This is the fifth paragraph. This is the fifth paragraph. This is the fifth paragraph. This is the fifth paragraph. This is the fifth paragraph.

First subfigure.

(a) First subcaption.

Second subfigure.

(b) Second subcaption.

Figure H.6. This figure has two subfigures arranged vertically.

```
1
2 \MyRepeat{This is the fifth paragraph. }{10}

1
2 % See pages 4--5 of
3 % http://mirrors.ibiblio.org/CTAN/macros/latex/contrib/caption/subcaption.pdf
4 % for how to use \subcaptionbox.
5 \begin{figure}[ht]
6 % Center the entire figure (containing the two subfigures).
7 \centering
8 % The \subcaptionbox for the first subfigure.
9 \vbox{\subcaptionbox % use \vbox to stack subcaption boxes vertically
10 % The first subcaption with a \label.
11 % Use \ref{sf:two-vertical-parts-a} to print the subcaption number.
12 {First subcaption.\label{sf:two-vertical-parts-a}}
13 [2in]%
14 {\bfseries First subfigure.}}%
15 % Put \baselineskip blank space between the subfigures.
16 \vspace*{\baselineskip}
17 % The \subcaptionbox for the second subfigure.
18 \vbox{\subcaptionbox % use \vbox to stack subcaption boxes vertically
19 {Second subcaption.\label{sf:two-vertical-parts-b}}
20 [2in]%
21 {\bfseries Second subfigure.}}%
22 \caption{This figure has two subfigures arranged vertically.}
23 \label{fi:two-vertical-parts}
24 \end{figure}
25 \ix{figure!subfigures!\(\text{2 rows} \times \text{1 column}\)}
```

This is the sixth paragraph. This is the sixth paragraph. This is the sixth paragraph. This is the sixth paragraph. This is the sixth paragraph. This is the sixth paragraph. This is the sixth paragraph. This is the sixth paragraph.

```
1
2 \MyRepeat{This is the sixth paragraph. }{10}

1
2 % See pages 4--5 of
3 % http://mirrors.ibiblio.org/CTAN/macros/latex/contrib/caption/subcaption.pdf
4 % for how to use \subcaptionbox.
5 \begin{figure}[ht]
6 \centering
7 \subcaptionbox
```

<p>First subfigure.</p> <p>(a) First subcaption.</p>	<p>Second subfigure.</p> <p>(b) Second subcaption.</p>
<p>Third subfigure.</p> <p>(c) Third subcaption.</p>	<p>Fourth subfigure.</p> <p>(d) Fourth subcaption.</p>

Figure H.7. This figure has four parts.

```

8      {First subcaption.\label{sf:four-parts-a}}
9      [2in]%
10     {\bfseries First subfigure.}%
11     \hskip 0.5truein
12     \subcaptionbox
13       {Second subcaption.\label{sf:four-parts-b}}
14       [2in]%
15       {\bfseries Second subfigure.}%
16     \vspace*{\baselineskip}
17     \subcaptionbox
18       {Third subcaption.\label{sf:four-parts-c}}
19       [2in]%
20       {\bfseries Third subfigure.}%
21     \hskip 0.5truein
22     \subcaptionbox
23       {Fourth subcaption.\label{sf:four-parts-d}}
24       [2in]%
25       {\bfseries Fourth subfigure.}%
26     \caption{This figure has four parts.}
27     \label{fi:four-parts}
28     \end{figure}
29     \ix{figure!subfigures!\(\text{2 rows} \times \text{2 columns}\)}

```

This is the seventh paragraph. This is the seventh paragraph. This is the seventh paragraph. This is the seventh paragraph. This is the seventh paragraph. This is the seventh paragraph. This is the seventh paragraph. This is the seventh paragraph. This is the seventh paragraph. This is the seventh paragraph. This is the seventh paragraph.

```

1
2   \MyRepeat{This is the seventh paragraph. }{10}

```

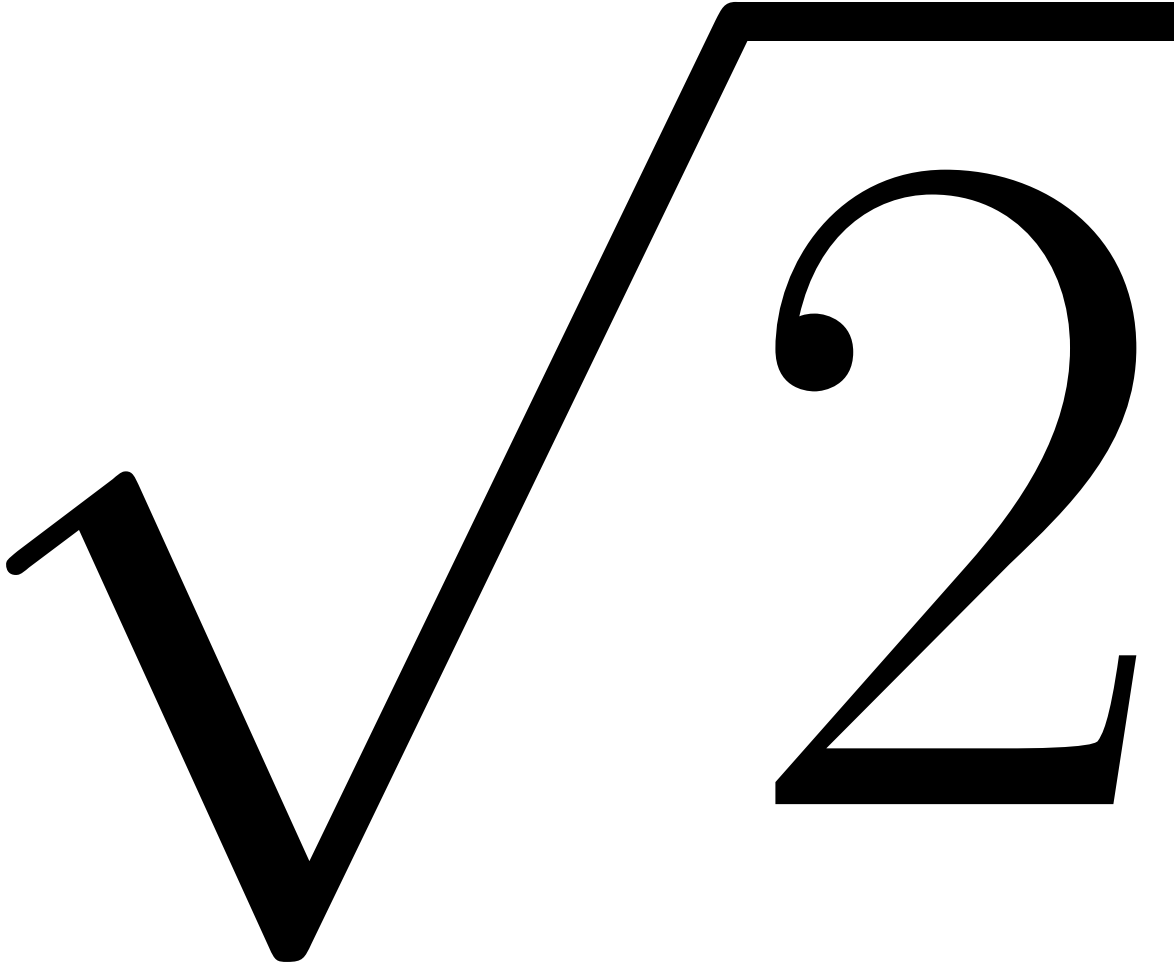



Figure H.8. A big “ $\sqrt{2}$ ”. L^AT_EX can make output big enough for T-shirts or posters. Square roots are printed with space before them, I put some negative horizontal space before this one to center it.

```
1
2 \newpage
3
4 \begin{figure}[ht]
5   \centering
6   % Use a 5" font.
7   {\fontsize{5in}{5in}\selectfont{\hspace*{-0.07em}\sqrt{2}}}
8   \caption{%
9     A big ‘‘\(\sqrt{2}\)’’.
10    \LaTeX\ can make output big enough for T-shirts or posters.
11    Square roots are printed with space before them,
12    I put some negative horizontal space before this one to center it.%
13  }
14 \end{figure}
15 \ix{figure!\(\sqrt{2}\)}
```

This is the figure.

Figure H.9. Allocation to Common Edge for $p(x_i) = 1 - e^{-x_i z}$

The remainder of this file tests having lots of figures. There are 20 figures in this test.



Figure H.10. Test figure 1 of 20.



Figure H.11. Test figure 2 of 20.



Figure H.12. Test figure 3 of 20.



Figure H.13. Test figure 4 of 20.



Figure H.14. Test figure 5 of 20.



Figure H.15. Test figure 6 of 20.

```
1
2 \newpage
3
4 The remainder of this file tests having lots of figures.
5 There are 20 figures in this test.
6
7 \begin{figure}[ht]
8   \centering
9   \includegraphics[scale=0.5]{gr-metapost-tally-01.pdf}
10  \caption{Test figure 1 of 20.}
11  \label{fi:1of20}
12 \end{figure}
13
14 \begin{figure}[ht]
15   \centering
```



Figure H.16. Test figure 7 of 20.



Figure H.17. Test figure 8 of 20.



Figure H.18. Test figure 9 of 20.



Figure H.19. Test figure 10 of 20.



Figure H.20. Test figure 11 of 20.



Figure H.21. Test figure 12 of 20.



Figure H.22. Test figure 13 of 20.

```
16 \includegraphics[scale=0.5]{gr-metapost-tally-02.pdf}
17 \caption{Test figure 2 of 20.}
18 \label{fi:2of20}
19 \end{figure}
20
21 \begin{figure}[ht]
22 \centering
23 \includegraphics[scale=0.5]{gr-metapost-tally-03.pdf}
24 \caption{Test figure 3 of 20.}
25 \label{fi:3of20}
26 \end{figure}
27
28 \begin{figure}[ht]
29 \centering
30 \includegraphics[scale=0.5]{gr-metapost-tally-04.pdf}
31 \caption{Test figure 4 of 20.}
32 \label{fi:4of20}
33 \end{figure}
```



Figure H.23. Test figure 14 of 20.

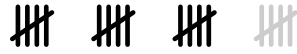

Figure H.24. Test figure 15 of 20.

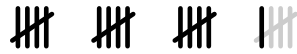

Figure H.25. Test figure 16 of 20.

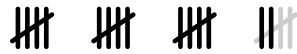

Figure H.26. Test figure 17 of 20.



Figure H.27. Test figure 18 of 20.

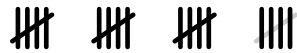

Figure H.28. Test figure 19 of 20.



Figure H.29. Test figure 20 of 20.

```

34
35 \begin{figure}[ht]
36   \centering
37   \includegraphics[scale=0.5]{gr-metapost-tally-05.pdf}
38   \caption{Test figure 5 of 20.}
39   \label{fi:5of20}
40 \end{figure}
41
42 \begin{figure}[ht]
43   \centering
44   \includegraphics[scale=0.5]{gr-metapost-tally-06.pdf}
45   \caption{Test figure 6 of 20.}
46   \label{fi:6of20}
47 \end{figure}
48
49 \begin{figure}[ht]
50   \centering
51   \includegraphics[scale=0.5]{gr-metapost-tally-07.pdf}

```

```

52 \caption{Test figure 7 of 20.}
53 \label{fi:7of20centered7}
54 \end{figure}
55
56 \begin{figure}[ht]
57 \centering
58 \includegraphics[scale=0.5]{gr-metapost-tally-08.pdf}
59 \caption{Test figure 8 of 20.}
60 \label{fi:8of20}
61 \end{figure}
62
63 \begin{figure}[ht]
64 \centering
65 \includegraphics[scale=0.5]{gr-metapost-tally-09.pdf}
66 \caption{Test figure 9 of 20.}
67 \label{fi:9of20}
68 \end{figure}
69
70 \begin{figure}[ht]
71 \centering
72 \includegraphics[scale=0.5]{gr-metapost-tally-10.pdf}
73 \caption{Test figure 10 of 20.}
74 \label{fi:10of20}
75 \end{figure}
76
77 \begin{figure}[ht]
78 \centering
79 \includegraphics[scale=0.5]{gr-metapost-tally-11.pdf}
80 \caption{Test figure 11 of 20.}
81 \label{fi:11of20}
82 \end{figure}
83
84 \begin{figure}[ht]
85 \centering
86 \includegraphics[scale=0.5]{gr-metapost-tally-12.pdf}
87 \caption{Test figure 12 of 20.}
88 \label{fi:12of20}
89 \end{figure}
90
91 \begin{figure}[ht]
92 \centering
93 \includegraphics[scale=0.5]{gr-metapost-tally-13.pdf}
94 \caption{Test figure 13 of 20.}
95 \label{fi:13of20}
96 \end{figure}
97
98 \begin{figure}[ht]
99 \centering
100 \includegraphics[scale=0.5]{gr-metapost-tally-14.pdf}
101 \caption{Test figure 14 of 20.}
102 \label{fi:14of20}
103 \end{figure}
104
105 \begin{figure}[ht]
106 \centering
107 \includegraphics[scale=0.5]{gr-metapost-tally-15.pdf}
108 \caption{Test figure 15 of 20.}
109 \label{fi:15of20}
110 \end{figure}
111
112 \begin{figure}[ht]
113 \centering
114 \includegraphics[scale=0.5]{gr-metapost-tally-16.pdf}
115 \caption{Test figure 16 of 20.}

```

```
116 \label{fi:16of20}
117 \end{figure}
118
119 \begin{figure}[ht]
120 \centering
121 \includegraphics[scale=0.5]{gr-metapost-tally-17.pdf}
122 \caption{Test figure 17 of 20.}
123 \label{fi:17of20}
124 \end{figure}
125
126 \begin{figure}[ht]
127 \centering
128 \includegraphics[scale=0.5]{gr-metapost-tally-18.pdf}
129 \caption{Test figure 18 of 20.}
130 \label{fi:18of20}
131 \end{figure}
132
133 \begin{figure}[ht]
134 \centering
135 \includegraphics[scale=0.5]{gr-metapost-tally-19.pdf}
136 \caption{Test figure 19 of 20.}
137 \label{fi:19of20}
138 \end{figure}
139
140 \begin{figure}[ht]
141 \centering
142 \includegraphics[scale=0.5]{gr-metapost-tally-20.pdf}
143 \caption{Test figure 20 of 20.}
144 \label{fi:20of20}
145 \end{figure}
```

I. FREQUENTLY ASKED QUESTIONS

This appendix lists all frequently asked questions. Each frequently asked question is assigned a number when I learn of it. Numbers are 1, 2, I started keeping track of frequently asked questions in this fashion on March 1, 2022.

<u>Priority</u>	<u>Color</u>
high or easy	red
medium	yellow
low	green
waiting on someone else	black
done	black
not assigned yet	gray

See the `ap-frequently-asked-questions.tex` file for the \LaTeX input for this appendix.

I.1 These questions need to be answered

I.2 These questions are waiting on a reply from someone other than Mark Senn

I.3 These questions have been answered

The subsection headings below are what part of the document the question is about.

Everywhere

FAQ 1. The \LaTeX input

(Mark Senn recommends using `\(a | b\)` instead)

gives

```
! LaTeX Error: Command \ttfamily invalid in math mode.
```

Reported by Negin Karisani.

A: In `thesis.tex`, change

```
\DefineShortVerb{\|} % so "|verbatim|" will be verbatim
```

to

```
% \DefineShortVerb{\|} % so "|verbatim|" will be verbatim
```

Table of Contents

FAQ 2. I want text instead of page number to be the link in the table of contents. Asked by Danushka Menikkumbura on 2022-03-11.

A: In `PurdueThesis.cls` change `linktoc = page` to `linktoc = section`. I do not recommend doing this because

- you'll need to put this change in new `PurdueThesis.cls` files in the future

- people are used to using page numbers instead of chapter/section/etc. titles for where they start

J. GRAPHICS

There are many ways to make graphics for L^AT_EX. I like to use a system that uses L^AT_EX fonts so the appearance of the output is professional.

```
1 \chapter{GRAPHICS}
2
3 There are many ways to make graphics for \LaTeX.
4 I like to use a system that uses \LaTeX\ fonts
5 so the appearance of the output is professional.
```

J.1 MATLAB programming language

By default, MATLAB supports a subset of TeX markup [26].

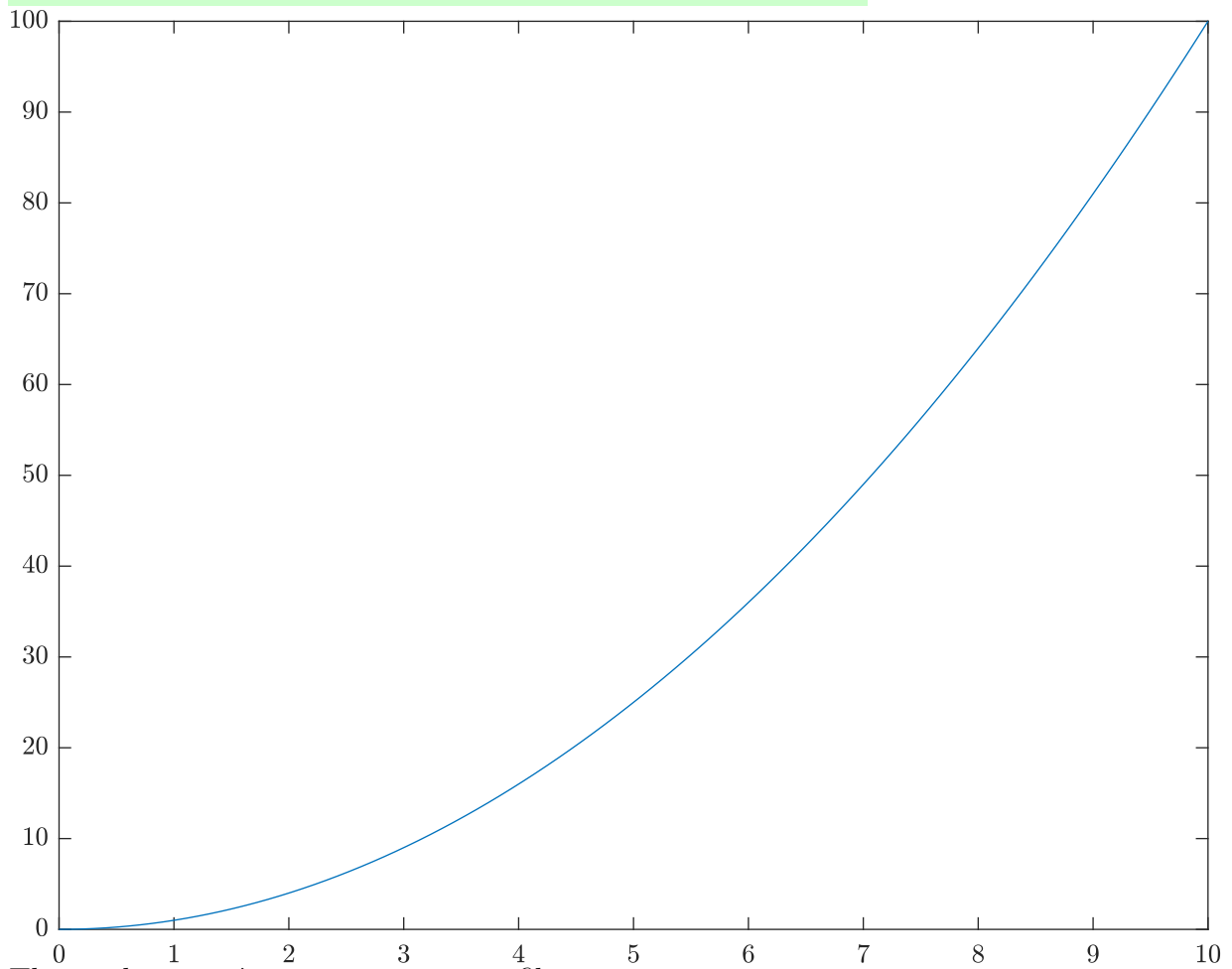

```
1 % gr_matlab.m    2021-11-11    Mark Senn <mark@purdue.edu>
2
3 % On Linux, I typed
4 %     lm matlab
5 %     matlab -nodesktop -nosplash -r gr_matlab
6 % to run this program.
7
8 % See
```

```

9 % https://www.mathworks.com/matlabcentral/answers/346436-how-to-use-latex-interpreter-for-xticklabels
10 % Do axis labels using LaTeX.
11 set(groot, 'defaultAxesTickLabelInterpreter', 'latex');
12 % Do legends using LaTeX.
13 set(groot, 'defaultLegendInterpreter', 'latex');
14 % Do text using LaTeX.
15 set(groot, 'defaulttextinterpreter', 'latex');
16
17 x = linspace(0,10,100);
18 y = x .^ 2;
19 plot(x, y);
20 saveas(gcf, '../graphics/gr-matlab.pdf');
21
22 % The following line worked for me on Linux.
23 !pdfcrop ../graphics/gr-matlab.pdf ../graphics/gr-matlab.pdf;
24
25 exit;

```

I typed, on Linux, `matlab -nodisplay -nodesktop -nosplash -r gr_matlab` in the `misc` subdirectory to make the `graphics/gr-matlab.pdf` output file.

```

1
2 \section{MATLAB programming language}
3 \ix{MATLAB programming language}
4
5 \def\gray#1{\colorbox{gray!15}{#1}}
6 \def\lightred#1{\colorbox{red!15}{#1}}
7 \def\lightgreen#1{\colorbox{green!20}{#1}}
8 \lightgreen{
9   By default,
10  MATLAB supports a subset of TeX markup
11  \cite{mathworks-help-center-text-properties}.
12 }
13
14 \includegraphics{gr-matlab.pdf}
15
16 This is the |misc/gr_matlab.m| input file:
17 \MyI{misc/gr_matlab.m}
18
19 I typed, on Linux,
20 \Shell{matlab -nodisplay -nodesktop -nosplash -r gr\_matlab}
21 in the |misc| subdirectory
22 to make the |graphics/gr-matlab.pdf| output file.

```

J.2 METAPOST programming language

MetaPost uses L^AT_EX fonts.

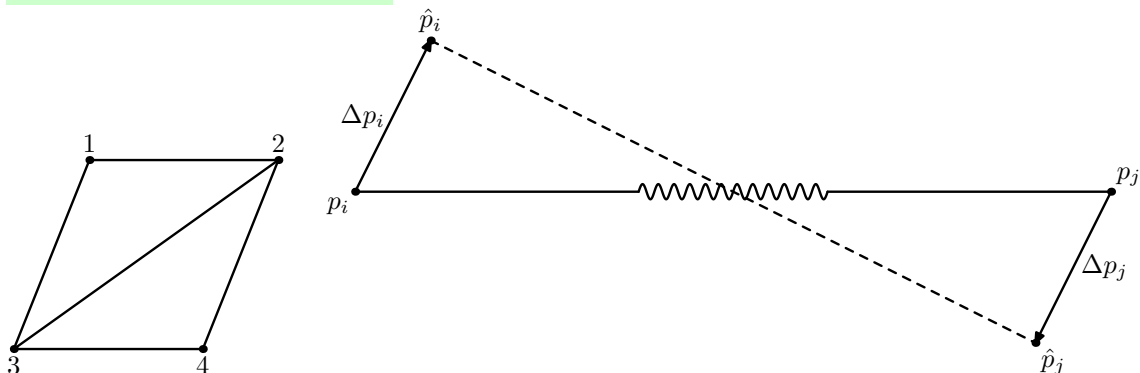

This is the misc/gr-metapost-kim.mp input file:

```

1  % gr-metapost.mp 2021-11-16 Mark Senn https://bit.ly/markseenn
2  %
3  % Thanks to Yanghyun Kim for asking how to do this figure.
4  %
5
6  prologues := 3; % make .eps files with embedded fonts
7
8  outputtemplate := "%j-%c.mps"; % make output files gr-metapost-1.mps and gr-metapost-2.mps
9
10 beginfig(1);
11   pickup pencircle scaled 1pt; % line width
12
13   u := 0.5cm; % unit size
14
15   deltax := 5u;
16   deltay := 5u;
17   xoff := 2u;
18
19   pair ll, lr, ul, ur;
20   ll := (0, 0); % lower left point
21   lr := ll + (deltax, 0); % lower right point
22   ul := ll + (xoff, deltay); % upper left point
23   ur := ul + (deltax, 0); % upper right point
24
25   draw ll--lr--ur--ul--ll;
26   draw ll--ur;
27
28   dotlabel.top(btex 1 etex, ul); % top label
29   dotlabel.top(btex 2 etex, ur); % top label
30   dotlabel.bot(btex 3 etex, ll); % bottom label
31   dotlabel.bot(btex 4 etex, lr); % bottom label
32 endfig;
33
34 beginfig(2);
35   pickup pencircle scaled 1pt; % line width
36
37   u := 2cm; % unit size
38
39   deltax := 5u;
40   deltay := 1u;
41   xoff := 0.5u;
42
43   pair ll, lr, ul, ur;
44   ll := (0, 0); % lower left point
45   ur := ll + (deltax, 0); % upper right point
46   ul := ll + (xoff, deltay); % upper left point
47   lr := ur + (-xoff, -deltay); % lower right point
48
49   dotlabel.llft(btex $p_i$ etex, ll); % lower left label
50   label.lft( btex $\Delta p_i$ etex, 1/2[ll,ul]); % left label
51   dotlabel.top( btex ${\hat p}_i$ etex, ul); % upper left label
52
53   dotlabel.lrt(btex ${\hat p}_j$ etex, lr); % lower right label
54   label.rt( btex $\Delta p_j$ etex, 1/2[lr,ur]); % right label
55   dotlabel.urt(btex $p_j$ etex, ur); % upper right label
56
57   drawarrow ll--ul;
58   drawarrow ur--lr;
59   draw ul--lr dashed evenly;
60   draw ll--3/8[ll,ur];
61   draw 3/8[ll,ur]{up}
62   for i = 0 upto 360:

```

```

63         ..3/8[ll,ur] + ((i/360)*(deltax/4), (u/20)*sind(12i))
64     endfor;
65     draw 5/8[ll,ur]--ur;
66 endfig;
67
68 end.

```

I typed, on Linux,

```

mpost gr-metapost-kim
epstopdf gr-metapost-kim-1.mps; epstopdf gr-metapost-kim-2.mps
mv -i gr-metapost-kim-1.pdf gr-metapost-kim-2.pdf ../graphics

```

to run MetaPost and make two PDF files, `gr-metapost-kim-1.pdf` and `gr-metapost-kim-2.pdf`, and move them to the graphics subfolder.

```

1
2 \section{\protect\METAPOSTLogo\ programming language}
3 \index{METAPOST@METAPOSTLogo}
4 \todoindex{\METAPOSTLogo}
5
6 \lightgreen{\MetaPostLogo\ uses \LaTeX\ fonts.}
7 \todoindex{\MetaPostLogo}
8
9 \includegraphics{gr-metapost-kim-1.pdf}
10 \hspace*{0.1truein}
11 \includegraphics{gr-metapost-kim-2.pdf}
12
13 This is the |misc/gr-metapost-kim.mp| input file:
14 \MyI{misc/gr-metapost-kim.mp}
15
16 I typed, on Linux,\\
17 \hspace*{3\parindent}\Shell{mpost gr-metapost-kim}\\
18 \hspace*{3\parindent}\Shell{epstopdf gr-metapost-kim-1.mps; epstopdf gr-metapost-kim-2.mps}\\
19 \hspace*{3\parindent}\Shell{mv -i gr-metapost-kim-1.pdf gr-metapost-kim-2.pdf ../graphics}\\
20 to run MetaPost and make two PDF files, |gr-metapost-kim-1.pdf| and |gr-metapost-kim-2.pdf|,
21 and move them to the graphics subfolder.

```

J.2.1 Tally example

Whenever I use files with numbers in them I like to put leading zeros in the names so they will be listed in order in the directory.

These 20 graphics (`gr-metapost-tally-01.pdf` through `gr-metapost-tally-20.pdf`)

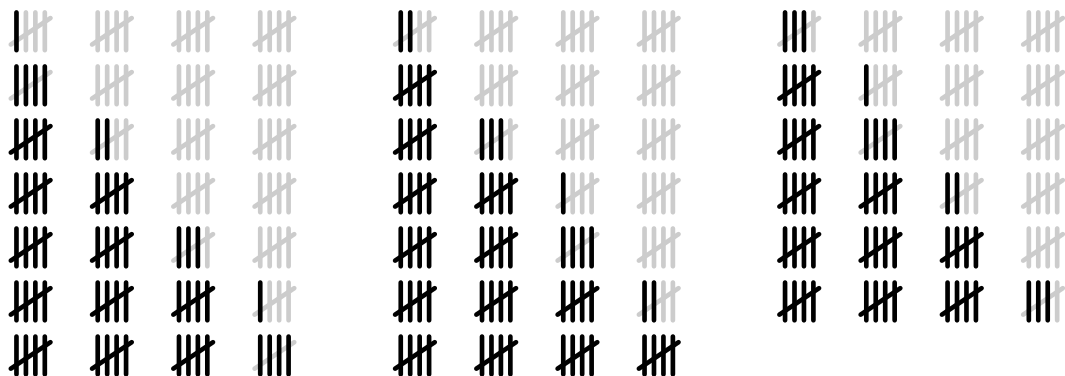

were produced by

```

1 %
2 % gr-metapost-tally.mp 2022-01-14 Mark Senn https://bit.ly/markseenn
3 %
4 % Make 20 .pdf files for the tally mark representations for 1 to 20.
5 %
6 % Whenever I use files with numbers in them I like to put leading zeros
7 % in the names so they will be listed in order in the directory.
8 %
9 % Do these commands:
10 % mpost gr-metapost-tally
11 % epspdf gr-metapost-tally-1.mps; mv gr-metapost-tally-1.pdf gr-metapost-tally-01.pdf
12 % epspdf gr-metapost-tally-2.mps; mv gr-metapost-tally-2.pdf gr-metapost-tally-02.pdf
13 % ...
14 % epspdf gr-metapost-tally-9.mps; mv gr-metapost-tally-9.pdf gr-metapost-tally-09.pdf
15 % epspdf gr-metapost-tally-20.mps; mv gr-metapost-tally-20.pdf gr-metapost-tally-20.pdf
16 %
17 % If you use bash you can do
18 % for i in $(seq 1 20); \
19 % do epspdf gr-tally- $i$ .mps ; printf -v var "%02d" " $i$ "; mv gr-tally- $i$ .pdf gr-tally- $\$var$ .pdf; \
20 % done
21 % to do all the lines that start with epspdf.
22 %
23
24 prologues := 3;
25 outputtemplate := "gr-%j-%c.mps";
26 outputformat := "eps";
27
28 % Define dimensions.
29 adjust = 0.15cm; % x and y adjustment
30 dx = 0.25cm; % delta x
31 h = 1cm; % tally height
32 s = 1cm; % spacing between groups of tally marks
33
34 % Define number of tally marks.
35 n = 20; % number of marks
36
37 % Compute the tally mark paths.
38 path p[];
39 x := 0; xstart := x;
40 for i = 1 upto n:
41   if (i mod 5 = 1):
42     p[i] = ((x,0)--(x,h)); x := x + dx;
43   fi;
44   if (i mod 5 = 2):
45     p[i] = ((x,0)--(x,h)); x := x + dx;
46   fi;
47   if (i mod 5 = 3):
48     p[i] = ((x,0)--(x,h)); x := x + dx;
49   fi;
50   if (i mod 5 = 4):
51     p[i] = ((x,0)--(x,h));
52   fi;
53   if (i mod 5 = 0):
54     p[i] = ((xstart-adjust,adjust)--(x+adjust,h-adjust));
55     x := x + dx + adjust + s; xstart := x;
56   fi;
57 endfor;
58 show p[1];
59
60 %
61 % Write the tally-*.mps files
62 %
63
64 for i = 1 upto n:

```

```

65
66   beginfig(i);
67
68       % Define pen---this must go between beginfig and endfig.
69       pen mypen;
70       mypen = pencircle scaled 3.5;
71       pickup mypen;
72
73       % Draw gray tally marks.
74       for j = i+1 upto n:
75           draw p[j] withcolor 0.8white;
76       endfor;
77
78       % Draw black tally marks.
79       % Do this last so the dark tally marks
80       % will be on top of the light tally marks.
81       for j = 1 upto i:
82           draw p[j] withcolor black;
83       endfor;
84
85   endfig;
86
87 endfor;
88
89 end.

1
2 \subsection{Tally example}
3 \label{ss:tally-example}
4
5 Whenever I use files with numbers in them I like to put leading zeros
6 in the names so they will be listed in order in the directory.
7
8 These 20 graphics (|gr-metapost-tally-01.pdf| through |gr-metapost-tally-20.pdf|)
9
10 \vspace*{6pt}
11
12 {%
13     % Let * represent zero or more spaces!
14     % Method 1: \def\g#1{ requires using \g*{10} for 10.
15     %           Two shifted characters, { and } are needed.
16     % Method 2: \def\g#1/{ requires using \g*10/ for 10.
17     %           One unshifted character, / is needed.
18     \def\g#1/{\includegraphics[scale=0.5]{gr-metapost-tally-#1.pdf}}%
19
20     % Note that tabular* instead of tabular is used below.
21     % The {\textwidth} makes the total width of the table the width
22     % of the printed area of the page.
23     % The @{\kern2\parindent} puts blank space the width of two
24     % paragraph indents before the first column.
25     % The @{\extracolsep{\fill}} adds \fill space between all subsequent
26     % columns.
27     % The lll left justifies the next three columns.
28     % after the column.
29     % The @{\kern2\parindent} puts blank space the width of two
30     % paragraph indents before the first column.
31     \begin{tabular*}{\textwidth}{@{\kern2\parindent}@{\extracolsep{\fill}}lll@{\kern2\parindent}}%
32         \g 01/& \g 02/& \g 03/\
33         \g 04/& \g 05/& \g 06/\
34         \g 07/& \g 08/& \g 09/\
35         \g 10/& \g 11/& \g 12/\
36         \g 13/& \g 14/& \g 15/\
37         \g 16/& \g 17/& \g 18/\
38         \g 19/& \g 20/\

```

```

39 \end{tabular*}%
40 }
41 \noindent were produced by
42
43 \MyI{misc/gr-metapost-tally.mp}
44

```

J.3 Python programming language

Python can be set up to use L^AT_EX fonts.

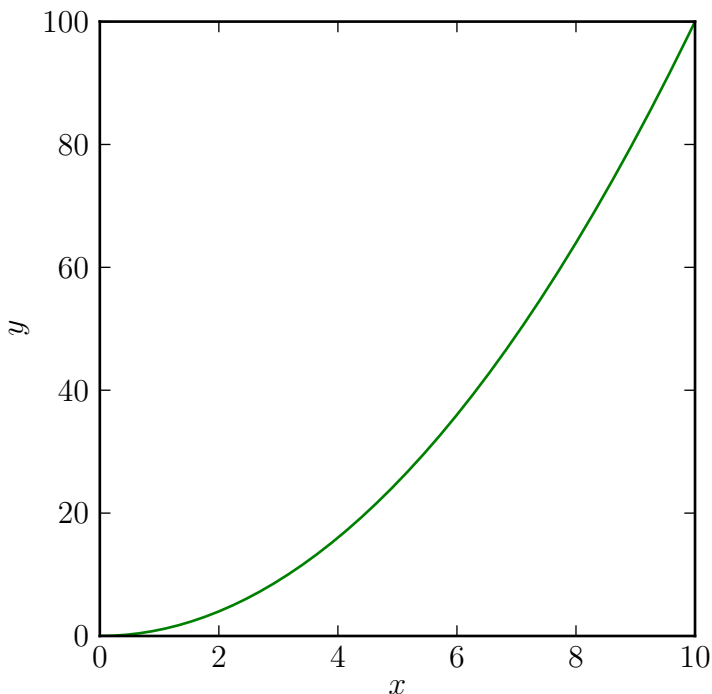

This is the misc/gr-python2.py input file:

```

1  #!/bin/python2
2
3  #  gr-python2.py    2022-02-11    Mark Senn <mark@purdue.edu>
4
5  # On Linux, I typed
6  #    ./gr-python2.py
7  # to run this program.
8
9  import matplotlib as mpl
10
11 # From https://matplotlib.org/stable/gallery/text_labels_and_annotations/tex_demo.html
12 #   You can use TeX to render all of your Matplotlib text by setting
13 #   rcParams["text.usetex"] (default: False) to True. This requires
14 #   that you have TeX and the other dependencies described in the
15 #   Text rendering With LaTeX tutorial properly installed on your
16 #   system. Matplotlib caches processed TeX expressions, so that
17 #   only the first occurrence of an expression triggers a TeX
18 #   compilation. Later occurrences reuse the rendered image from the
19 #   cache and are thus faster.
20 mpl.rcParams['text.usetex'] = True

```



```

21
22 # From https://stackoverflow.com/questions/2801882/generating-a-png-with-matplotlib-when-display-is-undefined
23 # # Force matplotlib to not use any Xwindows backend.
24 # matplotlib.use('Agg')
25 mpl.use('Agg')
26
27 import matplotlib.pyplot as plt
28
29 plt.figure(figsize=(4,4))
30
31 import numpy as np
32
33 x = [ ]
34 y = [ ]
35 for i in range(0,1001):
36     x.append(i / 100.0)
37     y.append((i/100.0) ** 2)
38
39 # Normally, there is extra space to the left, right, top, and bottom
40 # of plotted data in a graph. This gets rid of that space.
41 plt.autoscale(enable=None, tight=True)
42
43 plt.plot(x, y, 'g')
44
45 plt.xlabel('$x$')
46 plt.ylabel('$y$')
47
48 plt.savefig('../graphics/gr-python2.pdf')

```

I typed, on Linux, `./gr-python2.py` in the `misc` subdirectory to make the `graphics/gr-python2.pdf` output file.

```

1 \section{Python programming language}
2 \ix{Python programming language}
3
4 \lightgreen{Python can be set up to use \LaTeX\ fonts.}
5
6 \includegraphics{gr-python2.pdf}
7
8 This is the |misc/gr-python2.py| input file:
9 \MyI{misc/gr-python2.py}
10
11 I typed, on Linux,
12 \Shell{./gr-python2.py}
13 in the |misc| subdirectory
14 to make the |graphics/gr-py|\|
15 |thon2.pdf| output file.

```

J.4 R programming language

R can be set up to use \LaTeX fonts.

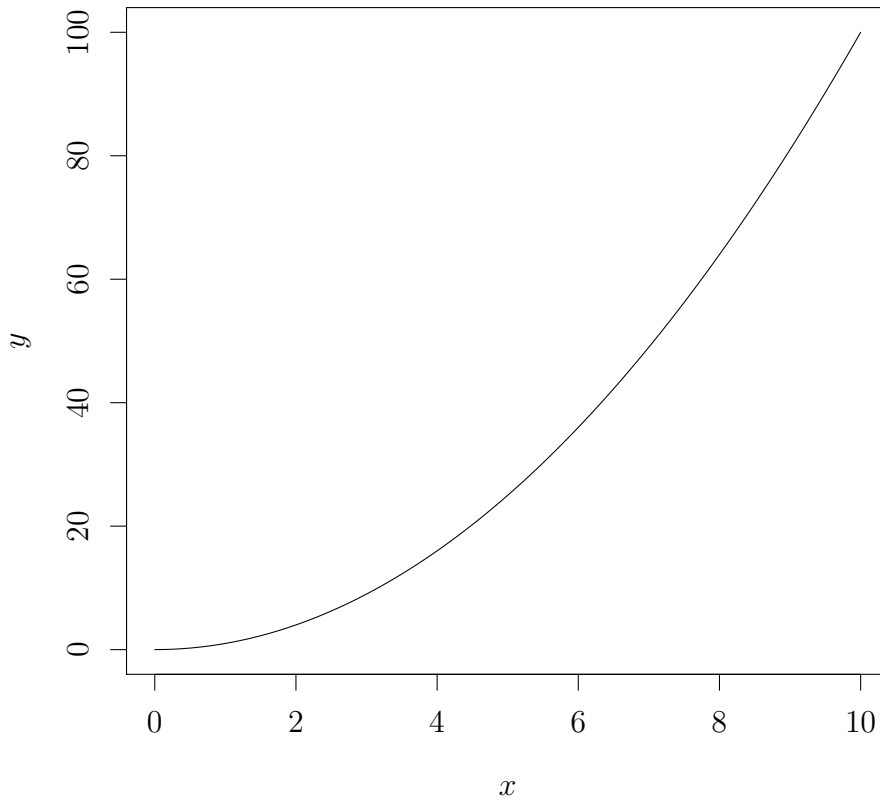

This is the misc/gr-r.R input file:

```

1 # gr-r.R    2021-11-24    Mark Senn    https://bit.ly/markseenn
2
3 # See
4 #   https://texample.net/tikz/examples/tikzdevice-demo/
5 # for information on tikzDevice.
6
7 # Load the tikzDevice package.
8 # If you don't have it, install with
9 #   install.packages("tikzDevice", repos="http://R-Forge.R-project.org")
10 require(tikzDevice)
11
12 tikz(file = '../gr-r.tex', height=5, width=5)
13
14 curve(x^2, from=0, to=10, xlab="$x$", xlim=c(0,10), ylab="$y$", ylim=c(0,100))
15
16 dev.off()

```

I typed, on Linux, **R CMD BATCH gr-r** in the misc subdirectory to make the `gr-r.tex` outfile file.

```

1
2 \section{R programming language}
3 \ix{R programming language}
4
5 \lightgreen{R can be set up to use \LaTeX\ fonts.}

```

```

6
7 \input{gr-r.tex}
8
9 This is the |misc/gr-r.R| input file:
10 \MyI{misc/gr-r.R}
11
12 I typed, on Linux,
13 \Shell{R CMD BATCH gr-r}
14 in the |misc| subdirectory to make the |gr-r.tex| outfile file.

```

J.5 TikZ L^AT_EX package

TikZ uses L^AT_EX fonts.

```

1
2 \section{\TikZLogo\ \LaTeX\ package}
3 \index{\TikZ@\TikZLogo\ \LaTeX\ package}
4 \todoindex{\TikZLogo\ \LaTeX\ package}
5
6 \lightgreen{\TikZLogo\ uses \LaTeX\ fonts.}

```

J.5.1 Clock example

```

1
2 \subsection{Clock example}
3 \index{clock \TikZLogo\ example}
4 \todoindex{clock \TikZLogo\ example}

```

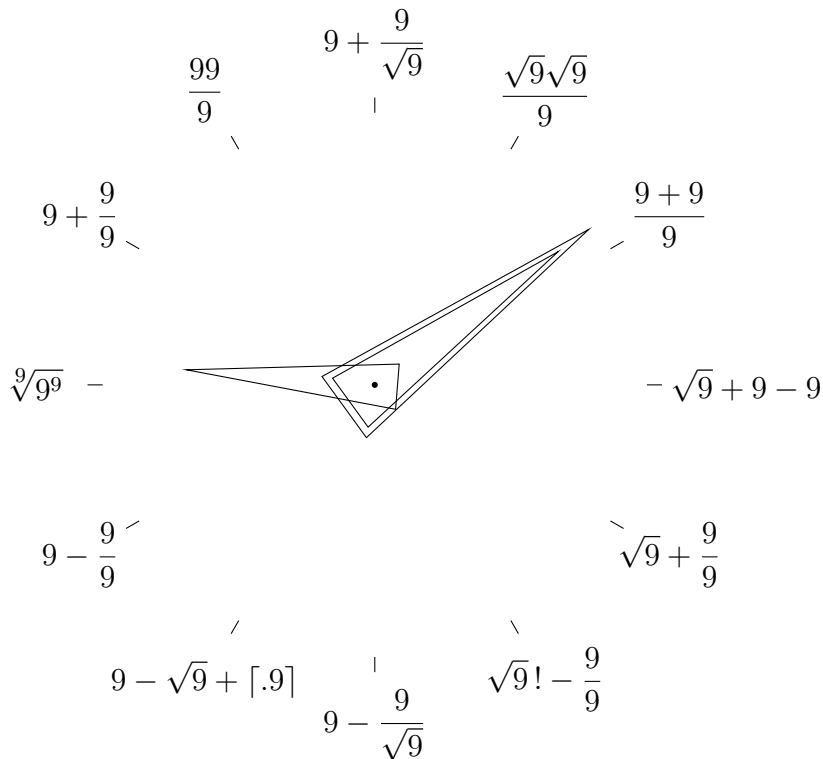

```

1
2 \index{\TikZ@\TikZLogo}

```

```

3
4 \hbox to\textwidth{%
5   \hfil
6   % The idea for this clock was originally from a Google+ posting by Afamefuna ‘‘Ferdy’’ Ibeabuchia.
7   \begin{tikzpicture}
8     \def\CenterRadius{0.04cm}
9     \def\InnerTickRadius{3.6cm}
10    \def\OuterTickRadius{3.8cm}
11    % Make \LR be an abbreviation for \LabelRadius so the
12    % lines below will fit within the width of the page.
13    \def\LabelRadius{4.5cm}    \let\LR=\LabelRadius
14    \def\HourHandRadius{2.5cm} \def\HourHandBase{0.3cm}
15    \def\MinuteHandRadius{3cm} \def\MinuteHandBase{0.4cm}
16    \def\SecondHandRadius{3.5cm} \def\SecondHandBase{0.5cm}
17    \def\DS{\displaystyle}
18    \fill (0,0) circle (\CenterRadius);
19    \foreach \i in {0,30,...,330}
20    \draw (\i:\InnerTickRadius)--(\i:\OuterTickRadius);
21    \node at ( 0:\LR) {$\DS \quad \sqrt{9 + 9 - 9}$};           % 3
22    \node at ( 30:\LR) {$\DS \frac{9+9}{9}$};                 % 2
23    \node at ( 60:\LR) {$\DS \frac{\sqrt{9}\sqrt{9}}{9}$};   % 1
24    \node at ( 90:\LR) {$\DS 9 + \frac{9}{\sqrt{9}}$};       % 12
25    \node at (120:\LR) {$\DS \frac{99}{9}$};                 % 11
26    \node at (150:\LR) {$\DS 9 + \frac{99}{9}$};            % 10
27    \node at (180:\LR) {$\DS \sqrt[\scriptstyle 9]{9^9}$};   % 9
28    \node at (210:\LR) {$\DS 9 - \frac{99}{9}$};            % 8
29    \node at (240:\LR) {$\DS 9 - \sqrt{9} + \lceil.9\rceil$}; % 7
30    \node at (270:\LR) {$\DS 9 - \frac{9}{\sqrt{9}}$};     % 6
31    \node at (300:\LR) {$\DS \sqrt{9},! - \frac{99}{9}$};   % 5
32    \node at (330:\LR) {$\DS \sqrt{9} + \frac{99}{9}$};     % 4
33    % In the following
34    % ABBREVIATION      DESCRIPTION
35    % deg                degrees
36    % min                minutes
37    % sec                seconds
38    % for second hand:
39    % (9 sec/60 sec) * 360 deg = 54 deg;
40    % 90 deg - 54 deg = 36 deg
41    \draw[rotate around={36:(0,0)}]
42    (-\SecondHandBase,\SecondHandBase) -- (\SecondHandRadius,0)
43    -- (-\SecondHandBase,-\SecondHandBase) -- cycle;
44    % for minute hand:
45    % (9 min/60 min) * 360 deg = 54 deg;
46    % 90 deg - 54 deg = 36 deg
47    \draw[rotate around={36:(0,0)}]
48    (-\MinuteHandBase,\MinuteHandBase) -- (\MinuteHandRadius,0)
49    -- (-\MinuteHandBase,-\MinuteHandBase) -- cycle;
50    % for hour hand:
51    % (9 min * (60 sec/1 min)) + 9 sec) / 3600 sec
52    % = 549 sec / 3600 sec = 0.1525
53    % The hour hand is 0.1525 of the way from 9:00 to 10:00.
54    % Each hour is 30 degrees on the clock, so the hour hand
55    % position is
56    % 30 deg * 0.1525 = 4.575 deg past 9:00
57    % 180 deg - 4.575 deg = 175.425 deg
58    \draw[rotate around={175.425:(0,0)}]
59    (-\HourHandBase,\HourHandBase) -- (\HourHandRadius,0)
60    -- (-\HourHandBase,-\HourHandBase) -- cycle;
61  \end{tikzpicture}
62  \hfil
63 }

```

J.5.2 Counter example

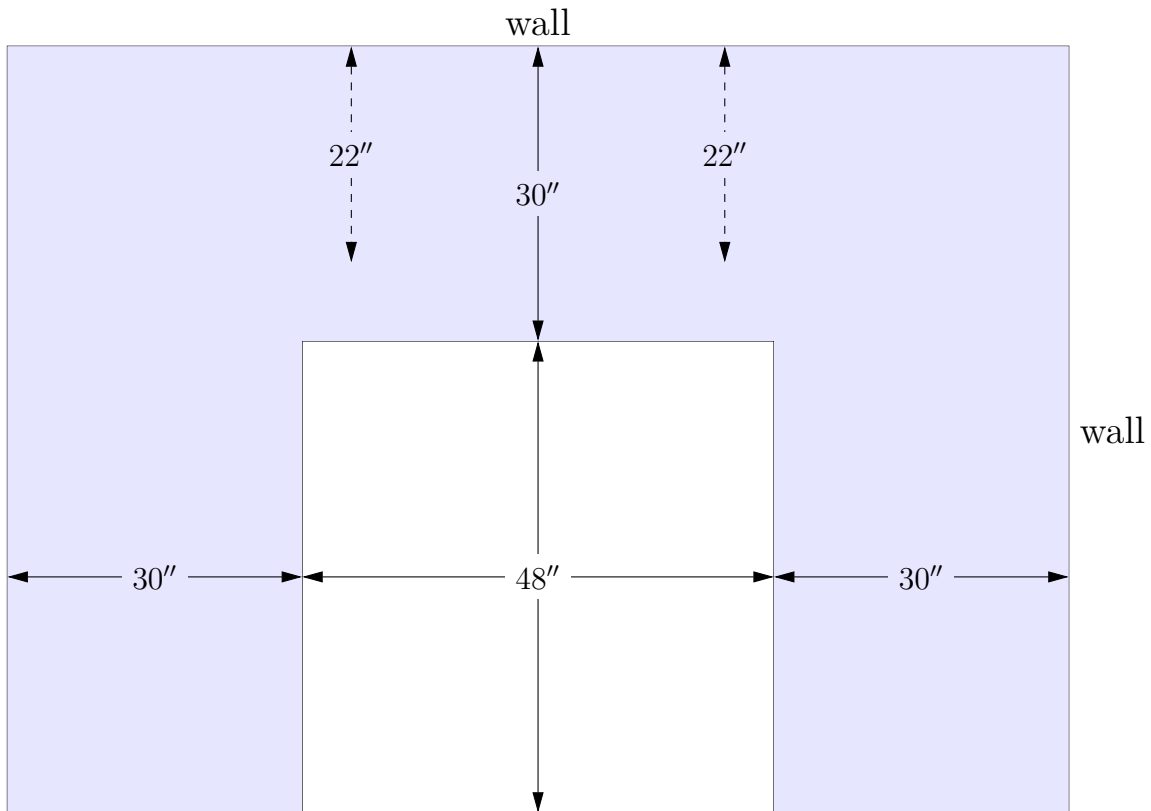

```

1
2 \newpage
3
4 \subsection{Counter example}
5 \index{Counter \TikZLogo\ example}
6 \todoindex{Counter \TikZLogo\ example}
7
8 \begin{tikzpicture}[scale=0.13]
9   % Define points.
10  \coordinate (p11) at ( 0, 78);
11  \coordinate (p14) at ( 35, 78);
12  \coordinate (p15) at ( 54, 78);
13  \coordinate (p16) at ( 73, 78);
14  \coordinate (p19) at (108, 78);
15  \coordinate (p24) at ( 35, 67);
16  \coordinate (p26) at ( 73, 67);
17  \coordinate (p35) at ( 54, 63);
18  \coordinate (p44) at ( 35, 56);
19  \coordinate (p46) at ( 73, 56);
20  \coordinate (p53) at ( 30, 48);
21  \coordinate (p55) at ( 54, 48);
22  \coordinate (p57) at ( 78, 48);
23  \coordinate (p69) at (108, 39);
24  \coordinate (p71) at ( 0, 24);
25  \coordinate (p72) at ( 15, 24);
26  \coordinate (p73) at ( 30, 24);
27  \coordinate (p75) at ( 54, 24);
28  \coordinate (p77) at ( 78, 24);
29  \coordinate (p78) at ( 93, 24);
30  \coordinate (p79) at (108, 24);

```

```

31 \coordinate (p81) at ( 0, 0);
32 \coordinate (p83) at ( 30, 0);
33 \coordinate (p85) at ( 54, 0);
34 \coordinate (p87) at ( 78, 0);
35 \coordinate (p89) at (108, 0);
36 % Put "wall" above drawing.
37 \draw (p15) node[above] {\large wall};
38 % Plot outer edge.
39 \draw (p81) -- (p11) -- (p19) -- (p89);
40 % Plot inner edge.
41 \draw (p83) -- (p53) -- (p57) -- (p87);
42 % Color the counter.
43 \fill[blue!10] (p81) -- (p11) -- (p19) -- (p89) -- (p87) -- (p57) -- (p53) -- (p83) -- cycle;
44 % Vertical measurement lines.
45 \draw[dashed, arrows = {Stealth[inset=0pt, angle=30:8pt]-Stealth[inset=0pt, angle=30:8pt]]
46 (p14) -- (p44);
47 \draw (p24) node[fill=blue!10] {$22''$};
48 \draw[arrows = {Stealth[inset=0pt, angle=30:8pt]-Stealth[inset=0pt, angle=30:8pt]] (p15) -- (p55);
49 \draw (p35) node[fill=blue!10] {$30''$};
50 \draw[dashed, arrows = {Stealth[inset=0pt, angle=30:8pt]-Stealth[inset=0pt, angle=30:8pt]]
51 (p16) -- (p46);
52 \draw (p26) node[fill=blue!10] {$22''$};
53 \draw[arrows = {Stealth[inset=0pt, angle=30:8pt]-Stealth[inset=0pt, angle=30:8pt]] (p55) -- (p85);
54 % Horizontal measurement lines.
55 \draw[arrows = {Stealth[inset=0pt, angle=30:8pt]-Stealth[inset=0pt, angle=30:8pt]] (p71) -- (p73);
56 \draw (p72) node[fill=blue!10] {$30''$};
57 \draw[arrows = {Stealth[inset=0pt, angle=30:8pt]-Stealth[inset=0pt, angle=30:8pt]] (p73) -- (p77);
58 \draw (p75) node[fill=white] {$48''$};
59 \draw[arrows = {Stealth[inset=0pt, angle=30:8pt]-Stealth[inset=0pt, angle=30:8pt]] (p77) -- (p79);
60 \draw (p78) node[fill=blue!10] {$30''$};
61 % Put "wall" to the right of drawing.
62 \draw (p69) node[right] {\large wall};
63 \end{tikzpicture}

```

J.5.3 Fourier transform example

The Fourier transform decomposes a function into the frequencies that make it up. The inverse Fourier transformation combines the contributions of all the different frequencies to recover the original function.

(Mark Senn <mark@purdue.edu> wrote sales@aavos.be on 2021-09-03 to ask permission to use [Fourier transform](#) as the starting point for an example *TikZ* figure. Dominique Demurie <sales@aavos.be> replied on 2021-09-06 with “I think it is not an original drawing from us either. We had it for years on our website, but I cannot remember where we got it from. We don’t mind you using it for a thesis.”)

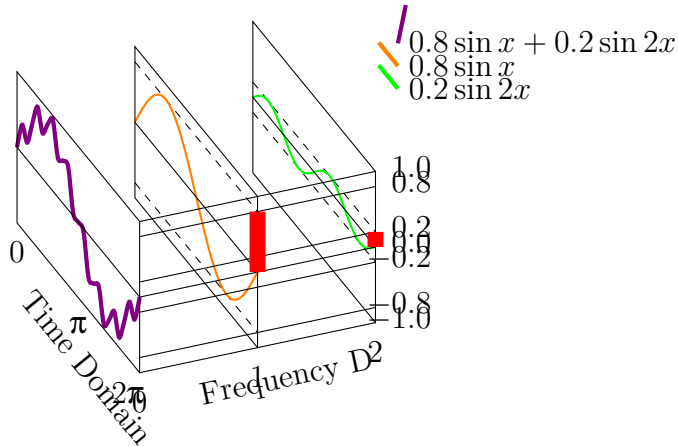

```

1
2 \subsection{Fourier transform example}
3 \index{Fourier transform \TikZLogo\ example}
4 \todoindex{Fourier transform \TikZLogo\ example}
5
6 The Fourier transform decomposes a function
7 into the frequencies that make it up.
8 The inverse Fourier transformation combines the contributions
9 of all the different frequencies to recover the original function.
10
11 (Mark Senn {\tt\char'074}mark@purdue.edu{\tt\char'076} wrote sales@aavos.be on 2021-09-03
12 to ask permission
13 to use
14 \href{https://aavos.eu/glossary/fourier-transform/}{Fourier transform}
15 as the starting point
16 for an example \TikZLogo\ figure.
17 Dominique Demurie {\tt\char'074}sales@aavos.be{\tt\char'076} replied
18 on 2021-09-06 with
19 ‘‘I think it is not an original drawing from us either.
20 We had it for years on our website,
21 but I cannot remember where we got it from.
22 We don’t mind you using it for a thesis.’’)
23
24 % Run this with
25 %   pdflatex --shell-escape t
26 % That makes the t.table.* files.
27 %
28 % See
29 %   https://ctan.math.washington.edu/tex-archive/graphics/pgf/base/doc/pgfmanual.pdf
30 %   PAGE   TOPIC
31 %   655    decorations.text library to draw text
32 %   1221   animations
33 %
34 % for text decorations, which includes text along a path information.
35 % Also see
36 %   https://tex.stackexchange.com/questions/427454/tikz-3dplot-and-rotation-of-coordinates
37 %   https://tex.stackexchange.com/questions/67573/tikz-shift-and-rotate-in-3d
38 %   http://tug.ctan.org/graphics/pgf/contrib/tikz-3dplot/tikz-3dplot_documentation.pdf
39 %   https://tex.stackexchange.com/questions/45848/rotate-node-text-and-use-relative-positioning-in-tikz
40
41 % was scale = 2
42 \begin{tikzpicture}[domain=0:6.283185, rotate around y=-55, scale=1]
43
44 % total plot
45 \begin{scope}[canvas is xy plane at z=0]
46 \node[below=3pt] at (0, -1) {0};

```

```

47 \node[below=3pt] at (3.141593, -1) {\pi$};
48 \node[below=5pt] at (5.683185, -1) {\$2\pi$};
49 \draw[ultra thick,color=violet] plot[id=total,smooth] function{0.8*sin(x)+0.2*sin(8*x)};
50 \draw[thin,color=black] (0,-1) -- (0,1) -- (6.283185,1) -- (6.283185,-1) -- cycle;
51 \draw[thin,color=black] (0,0) -- (6.283185,0);
52 \path[decorate,decoration={text along path},
53 % |\LARGE|
54 text={Time Domain}}] (0.1,-2) -- (6.283185,-2);
55 % $s(t)$
56 \end{scope}
57
58 % tall plot
59 \begin{scope}[canvas is xy plane at z=-1.5]
60 \draw[dashed] (0,0.8) -- (6.283185,0.8);
61 \draw[dashed] (0,-0.8) -- (6.283185,-0.8);
62 \draw[thick,color=orange] plot[id=tall,smooth] function{0.8*sin(x)};
63 \draw[thin,color=black] (0,-1) -- (0,1) -- (6.283185,1) -- (6.283185,-1) -- cycle;
64 \draw[thin,color=black] (0,0) -- (6.283185,0);
65 \end{scope}
66
67 % short plot
68 \begin{scope}[canvas is xy plane at z=-3.0]
69 \draw[dashed] (0, 0.2) -- (6.283185, 0.2);
70 \draw[dashed] (0,-0.2) -- (6.283185, -0.2);
71 \draw[thick,color=green] plot[id=short,smooth] function{0.2*sin(2*x)};
72 \draw[thin,color=black] (0,-1) -- (0,1) -- (6.283185,1) -- (6.283185,-1) -- cycle;
73 \draw[thin,color=black] (0,0) -- (6.283185,0);
74 \end{scope}
75
76 % frequency plot
77 \begin{scope}[canvas is zy plane at x=6.283185]
78 \node[below=3pt] at ( 0.0,-1) {0};
79 \node[below=3pt] at (-1.5,-1) {1};
80 \node[below=3pt] at (-3.0,-1) {2};
81 \draw[thin,color=black] (0,-1.0) -- (-3.0,-1.0); \node[above=-9pt] at (-3.3,-1.0) {\$-1.0$};
82 \draw[thin,color=black] (0,-0.8) -- (-3.0,-0.8); \node[above=-9pt] at (-3.3,-0.8) {\$-0.8$};
83 \draw[thin,color=black] (0,-0.2) -- (-3.0,-0.2); \node[above=-9pt] at (-3.3,-0.2) {\$-0.2$};
84 \draw[thin,color=black] (0, 0.0) -- (-3.0, 0.0); \node[above=-9pt] at (-3.3, 0.0) {\$\phantom{-}0.0$};
85 \draw[thin,color=black] (0, 0.2) -- (-3.0, 0.2); \node[above=-9pt] at (-3.3, 0.2) {\$\phantom{-}0.2$};
86 \draw[thin,color=black] (0, 0.8) -- (-3.0, 0.8); \node[above=-9pt] at (-3.3, 0.8) {\$\phantom{-}0.8$};
87 \draw[thin,color=black] (0, 1.0) -- (-3.0, 1.0); \node[above=-9pt] at (-3.3, 1.0) {\$\phantom{-}1.0$};
88 \draw[line width=6pt,color=red] (-1.5,0) -- (-1.5,0.8);
89 \draw[line width=6pt,color=red] (-3.0,0) -- (-3.0,0.2);
90 \path[decorate,decoration={text along path},
91 % |\LARGE|
92 text={Frequency Domain}}] (-0.8,-1.6) -- (-3.0,-1.6);
93 % $\omega$
94 \end{scope}
95
96 %% legend
97 %% Wolfram Language code:
98 %% In[1]:= ry[theta_] :=
99 %% {
100 %% {Cos[theta Degree], 0, Sin[theta Degree]},
101 %% {0, 1, 0},
102 %% {-Sin[theta Degree], 0, Cos[theta Degree]}
103 %% }
104 %%
105 %% ry[55] . {Pi, 0.7, -3.5}
106 %% # Out[] = {-1.06509, 0.7, -4.58096}
107 %% ry[55] . {(3/4)Pi, 0.7, -3.5}
108 %% # Out[] = {-1.51557, 0.7, -3.9376}
109
110 \draw[ultra thick,color=violet] (2.45782, 1.7, -4.33538) -- (1.06509, 0.7, -4.58096);

```



```

111     \node[right] at (1.06509, 0.7, -4.58096) {$0.8\sin x + 0.2\sin 2x$};
112     \draw[ultra thick,color=orange] ( 0.08509, 0.4, -4.58096) -- (1.06509, 0.4, -4.58096);
113     \node[right] at (1.06509, 0.4, -4.58096) {$0.8\sin x$};
114     \draw[ultra thick,color=green] ( 0.08509, 0.1, -4.58096) -- (1.06509, 0.1, -4.58096);
115     \node[right] at (1.06509, 0.1, -4.58096) {$0.2\sin 2x$};
116 \end{tikzpicture}

```

J.5.4 Glider example

The glider is a pattern from the Game of Life, and it's used as an emblem representing the hacker community.

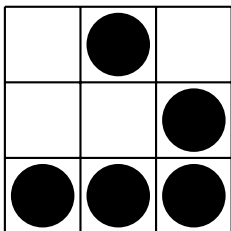

```

1
2 \subsection{Glider example}
3 \ix{Hirzel, Alex}
4 \index{glider \TikZLogo\ example}
5 \todoindex{glider \TikZLogo\ example}
6
7 The glider
8 is a pattern from the Game of Life,
9 and it's used as an emblem representing the hacker community.
10
11 \begin{tikzpicture}[thick]
12   \draw (0,0) grid (3,3);
13   \foreach \c in {(0,0), (1,0), (2,0), (2,1), (1,2)}
14     \fill \c + (0.5,0.5) circle (0.42);
15 \end{tikzpicture}

```

J.5.5 Tree example

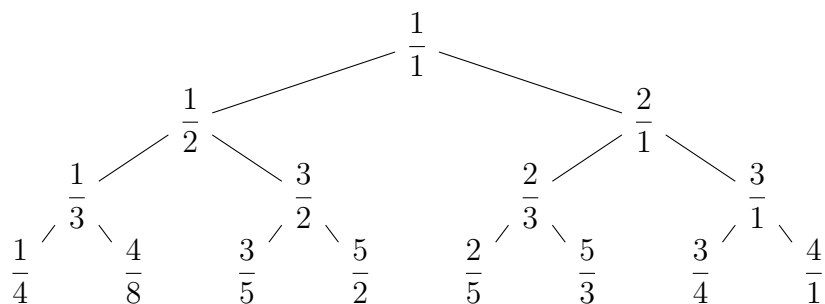

The node with value $\frac{n}{d}$

with additional conditions	has	with value
(none)	left child	$\frac{n}{n+d}$
(none)	right child	$\frac{n+d}{d}$
$n < d$	parent	$\frac{n}{d-n}$
$n = d$	no parent	(not applicable)
$n > d$	parent	$\frac{n-d}{d}$

```

1
2 \newpage
3
4 \subsection{Tree example}
5 \ix{???, ???}
6 \index{tree \TikZLogo\ example}
7 \todoindex{tree \TikZLogo\ example}
8
9 {
10 \def\f#1#2{\displaystyle\frac #1#2$}
11 \begin{tikzpicture}%
12 [%
13 level 1/.style={sibling distance=60mm},
14 level 2/.style={sibling distance=30mm},
15 level 3/.style={sibling distance=15mm}
16 ]
17 \node {\f 11}
18   child {node {\f 12$}
19     child {\f 13}
20     child {\f 14}}
21     child {\f 48}}
22   }
23   child {\f 32}
24     child {\f 35}}
25     child {\f 52}}
26   }
27 }
28 child {\f 21}
29   child {\f 23}

```

```

30     child {node {\f 25}}
31     child {node {\f 53}}
32   }
33   child {node {\f 31}}
34     child {node {\f 34}}
35     child {node {\f 41}}
36   }
37 };
38 \end{tikzpicture}
39
40 \vspace*{4pt}
41 The node with value \f nd\[2pt]
42 \indent\hspace*{4\parindent}
43 \begin{tabular}{@{}l|l|l@{}}
44   \bfseries with additional conditions& \bfseries has& \bfseries with value\\
45   \noalign{\vspace{2pt}}
46   (none)& left child& \f n{{n+d}}\\
47   \noalign{\vspace{12pt}}
48   (none)& right child& \f {{n+d}}d\\
49   \noalign{\vspace{12pt}}
50   $n<d$& parent& \f n{{d-n}}\\
51   \noalign{\vspace{12pt}}
52   $n=d$& no parent& (not applicable)\\
53   \noalign{\vspace{12pt}}
54   $n>d$& parent& \f {{n-d}}d\\
55 \end{tabular}
56 }

```

J.5.6 Yin and yang example

This Yin and yang example was done by Thomas G. Kristensen [27]. This is the “traditional Taijitu symbol from Chinese philosophy”.

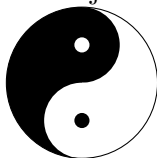

```

1
2
3 \subsection{Yin and yang example}
4
5 This Yin and yang example was done by Thomas G. Kristensen \cite{kristensen}.
6 This is the “traditional Taijitu symbol from Chinese philosophy”.
7 \ix{Kristensen, Thomas G.//Taijitu symbol//Yin and yang symbol}
8
9 \index{TikZ@TikZLogo}
10 \begin{tikzpicture}
11   % Yin and yang
12   % Author: Thomas G. Kristensen
13
14   % color one half of a unit circle
15   \begin{scope}
16     \clip (0,0) circle (1cm);
17     \fill[black] (0cm,1cm) rectangle (-1cm, -1cm);
18   \end{scope}
19
20   % fill heads
21   \fill[black] (0,0.5) circle (0.5cm);
22   \fill[white] (0,-0.5) circle (0.5cm);

```

```

23
24 % fill eyes
25 \fill[white] (0,0.5) circle (0.1cm);
26 \fill[black] (0,-0.5) circle (0.1cm);
27
28 % outer line
29 \draw (0,0) circle (1cm);
30
31 \end{tikzpicture}

```

J.6 Wolfram Language (Mathematica uses this)

Wolfram Language can be set up to use L^AT_EX fonts.

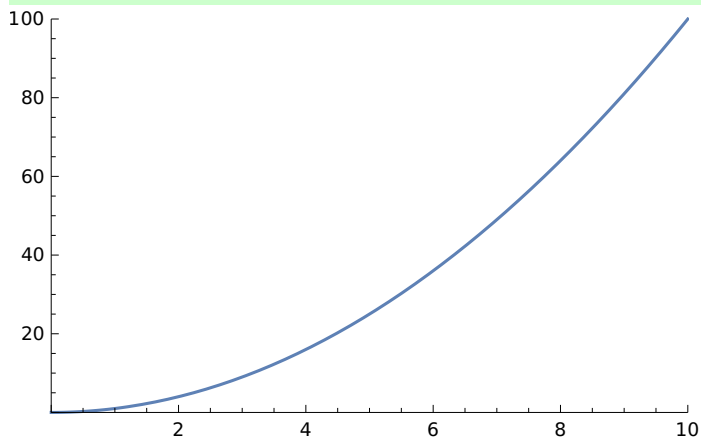

This is the misc/gr-mathematica.ma input file

```

1  (*
2     MaTeX is a Wolfram Language package to use LaTeX fonts in
3     Wolfram Language graphics. See
4         http://szhorvat.net/pelican/latex-typesetting-in-mathematica.html
5     for instructions on how to use MaTeX.
6  *)
7
8  (* Install MaTeX. *)
9  ResourceFunction["MaTeXInstall"] [];
10
11 (* Load MaTeX. *)
12 <<MaTeX';
13
14 latexStyle = {FontFamily->"Latin Modern Roman", FontSize->10};
15
16 g = Graphics[
17   Plot[x^2,
18     {x,0,10},
19     BaseStyle->latexStyle,
20     PlotRange->{{0,10},{0,100}}
21   ]
22 ];
23 I
24 Export["../graphics/gr-mathematica.pdf", g];

```

I typed, on Linux, `math < gr-mathematica.ma` in the misc subdirectory to make the `graphics/gr-mathematica.pdf` output file.

```

1
2 \section{Wolfram Language (Mathematica uses this)}

```

```
3 \ix{Mathematica}
4 \ix{Wolfram Language}
5
6 \lightgreen{Wolfram Language can be set up to use \LaTeX\ fonts.}
7
8 \includegraphics{gr-mathematica.pdf}
9
10 This is the |misc/gr-mathematica.ma| input file
11 \MyI{misc/gr-mathematica.ma}
12
13 I typed, on Linux,
14 \Shell{math < gr-mathematica.ma}
15 in the |misc| subdirectory
16 to make the |graphics/gr-mathematica.pdf| output file.
```

K. IGNORE THESE REFERENCES—THEY ARE WRONG

1 \chapter{IGNORE THESE REFERENCES---THEY ARE WRONG}

You may have seen these references on the web. Ignore them—they're wrong.

Purdue Online Writing Lab, IEEE Reference List [28]

The IEEE (The world's largest technical professional organization for the advancement of technology) has changed their references format from, for example,

[1] W. K. Chen, Linear Networks and Systems. Belmont, CA: Wadsworth Press, 2003.

to

[1] W. K. Chen, Linear Networks and Systems. Belmont, CA: Wadsworth Press, 2003.

See [29, page 2].

```
1
2 You may have seen these references on the web.
3 Ignore them---they're wrong.
4
5 \noindent
6 \textbf{Purdue Online Writing Lab, IEEE Reference List}
7 \cite{owl}
8
9 The IEEE
10 (The world's largest technical professional organization
11 for the advancement
12 of technology)
13 has changed their references format from,
14 for example,
15
16 \noindent
17 \begin{tabular}{@{}l@{}}
18 \noalign{\vspace*{6pt}}
19 [1] & W. K. Chen, Linear Networks and Systems. Belmont, CA: Wadsworth Press, \\
20 & \multispan{2}{2003.\hfil}\\
21 \noalign{\vspace*{6pt}}
22 \noalign{\noindent to}
23 \noalign{\vspace*{6pt}}
24 [1] & W. K. Chen, Linear Networks and Systems. Belmont, CA: Wadsworth Press, \\
25 & & 2003.\hfil \\
26 \noalign{\vspace*{6pt}}
27 \end{tabular}
28 See
29 \cite[page-2]{ieeedataport}.
```

L. LOGOS

These logos are defined in `pa-logos.sty`:

Input	Output
<code>\AMSMathLogo</code>	AMSMath
<code>\BibLaTeXLogo</code>	Bib \LaTeX
<code>\BiberLogo</code>	Biber
<code>\CalligraphicAMSLaTeXLogo</code>	<i>AMS-\LaTeX</i>
<code>\CircuiTikZLogo</code>	CircuiTikZ
<code>\CTANLogo{\texttt{CTAN}\xspace}</code>	CTAN
<code>\LaTeXLogo</code>	\LaTeX
<code>\LuaLaTeXLogo</code>	Lua \LaTeX
<code>\METAFONTLogo</code>	METAFONT
<code>\METAPOSTLogo</code>	METAPOST
<code>\MetaPostLogo</code>	MetaPost
<code>\NonCalligraphicAMSLaTeXLogo</code>	AMS- \LaTeX
<code>\PurdueThesisLogo</code>	PurdueThesis
<code>\PuThLogo</code>	PuTh
<code>\TeXLogo</code>	\TeX
<code>\TeXLiveLogo</code>	\TeX Live
<code>\TikZLogo</code>	TikZ
<code>\TeXUsersGroupLogo</code>	\TeX Users Group
<code>\TUGboatLogo</code>	<i>TUGboat</i>

```

1 \chapter{LOGOS}
2
3 These logos are defined in |pa-logos.sty|:
4
5 \begin{tabular}{@{}l@{}}
6 \toprule
7 \bfseries Input& \bfseries Output\\
8 \midrule
9 % From thesis.tex
10 % \newcommand{\tabularspace}{\noalign{\vspace*{2pt}}}
11 % \tabularspace
12 \verb+AMSMathLogo+& \AMSMathLogo\\[2pt]
13 \verb+BibLaTeXLogo+& \BibLaTeXLogo\\[2pt]
14 \verb+BiberLogo+& \BiberLogo\\[2pt]
15 \verb+CalligraphicAMSLaTeXLogo+& \CalligraphicAMSLaTeXLogo\\[2pt]
16 \verb+CircuiTikZLogo+& \CircuiTikZLogo\\[2pt]
17 \verb+CTANLogo{\texttt{CTAN}\xspace}+& \CTANLogo\\[2pt]
18 \verb+LaTeXLogo+& \LaTeXLogo\\[2pt]
19 \verb+LuaLaTeXLogo+& \LuaLaTeXLogo\\[2pt]
20 \verb+METAFONTLogo+& \METAFONTLogo\\[2pt]
21 \verb+METAPOSTLogo+& \METAPOSTLogo\\[2pt]
22 \verb+MetaPostLogo+& \MetaPostLogo\\[2pt]
23 \verb+NonCalligraphicAMSLaTeXLogo+& \NonCalligraphicAMSLaTeXLogo\\[2pt]
24 \verb+PurdueThesisLogo+& \PurdueThesisLogo\\[2pt]
25 \verb+PuThLogo+& \PuThLogo\\[2pt]

```

```
26 \verb+\TeXLogo+& \TeXLogo\\[2pt]
27 \verb+\TeXLiveLogo+& \TeXLiveLogo\\[2pt]
28 \verb+\TikZLogo+& \TikZLogo\\[2pt]
29 \verb+\TeXUsersGroupLogo+& \TeXUsersGroupLogo\\[2pt]
30 \verb+\TUGboatLogo+& \TUGboatLogo\\[2pt]
31 \bottomrule
32 \end{tabular}
```

M. MISCELLANEOUS

```
1 \chapter{MISCELLANEOUS}
2 \ix{miscellaneous//Miscellaneous appendix}
```

Demonstrate using a long Hungarian umlaut (double acute) (ő) in text and bibliography [30].

```
1 Demonstrate using a long Hungarian umlaut
2 (double acute)
3 (\H{o})
4 in text and bibliography
5 \cite{erdos1992}.
```

N. NUMBERS AND UNITS

```
1 \chapter{NUMBERS AND UNITS}
```

Note to self: scientific prefixes, scientific suffixes, tables.

The puthesis 2.0 and after documentclass uses the siunitx package with some extra definitions in the puthesis.cls file to do numbers and units.

```
1
2 Note to self: scientific prefixes, scientific suffixes, tables.
3
4 The puthesis 2.0 and after documentclass uses the siunitx
5 package with some extra definitions in the puthesis.cls
6 file to do numbers and units.
```

N.1 Number Examples

```
1
2 \section{Number Examples}
```

Input	Output	Comment
<code>\num{-0.12345}</code>	-0.123 45	note the small space after the “3”
<code>\num{-0.1234}</code>	-0.1234	note no space between the “3” and “4”
<code>\num{-.123}</code>	-0.123	the “0.” is inserted automatically
<code>\num{123}</code>	123	
<code>\num{1234}</code>	1234	
<code>\num{12345}</code>	12 345	note the small space after the “2”
<code>\num{2e4}</code>	2×10^4	
<code>\num{e5}</code>	10^5	
<code>\num{2.34567e6}</code>	$2.345\ 67 \times 10^6$	note the small space after the “5”

```
1 \noindent\begin{tabular}{@{}l|l|l@{}}
2 \bfseries Input& \bfseries Output& \bfseries Comment\\
3 \tabularspace
4 \verb+\num{-0.12345}+& \num{-0.12345}& note the small space after the ‘3’\\
5 \verb+\num{-0.1234}+& \num{-0.1234}&
6 \num{-0.1234}&
7 note no space between the ‘3’ and ‘4’\\
8 \verb+\num{-.123}+& \num{-.123}& the ‘0.’ is inserted automatically\\
9 \verb+\num{123}+& \num{123}\\
10 \verb+\num{1234}+& \num{1234}\\
11 \verb+\num{12345}+& \num{12345}& note the small space after the ‘2’\\
12 \verb+\num{2e4}+& \num{2e4}\\
13 \verb+\num{e5}+& \num{e5}\\
14 \verb+\num{2.34567e6}+& \num{2.34567e6}&
15 \num{2.34567e6}&
16 note the small space after the ‘5’\\
17 \end{tabular}
```

N.2 Unit Examples

```
1
2 \section{Unit Examples}
```

See page 111 for the complete list of units defined by PurdueThesis.

Input	Output	Comment
<code>\si{\kg}</code>	kg	kilogram
<code>\si{\m}</code>	m	meter
<code>\si{\kg\per\m\squared}</code>	kg m^{-2}	= kg/m ²

```

1
2 See page-\pageref{se:Complete-List-of-Units}
3 for the complete list
4 of units defined by \PurdueThesisLogo.
5
6 \noindent\begin{tabular}{@{}l}
7 \bfseries Input& \bfseries Output& \bfseries Comment\\
8 \tabularspace
9 \verb+\si{\kg}+& \si{\kg}& kilogram\\
10 \verb+\si{\m}+& \si{\m}& meter\\
11 \verb+\si{\kg\per\m\squared}+&
12 \si{\kg\per\m\squared}&
13 \ (= \si{\kg}/\si{\m\squared})\\
14 \end{tabular}

```

N.3 Combined Number and Unit Examples

```

1
2 \section{Combined Number and Unit Examples}

```

Input	Output	Comment
<code>\SI{12}{\kg}</code>	12 kg	12 kilograms
<code>\SI{34}{\m}</code>	34 m	34 meters
<code>\SI{4.5e3}{\kg\per\m\squared}</code>	$4.5 \times 10^3 \text{ kg m}^{-2}$	= $4.5 \times 10^3 \text{ kg/m}^2$

```

1 \begin{tabular}{@{}l}
2 \bfseries Input& \bfseries Output& \bfseries Comment\\
3 \tabularspace
4 \verb+\SI{12}{\kg}+& \SI{12}{\kg}& 12 kilograms\\
5 \verb+\SI{34}{\m}+& \SI{34}{\m}& 34 meters\\
6 % The next input line is too wide for the margins
7 % so I'm splitting it into pieces.
8 \verb+\SI{4.5e3}{\kg\per\m\squared}+&
9 \SI{4.5e3}{\kg\per\m\squared}&
10 \ (= \num{4.5e3}\, \si{\kg}/\si{\m\squared})\\
11 \end{tabular}

```

How many seconds are in a non-leap year that does not have any leap seconds?

$$\begin{aligned}
 \frac{365 \cancel{\text{d}}}{\text{y}} \times \frac{24 \cancel{\text{h}}}{\cancel{\text{d}}} \times \frac{60 \cancel{\text{min}}}{\cancel{\text{h}}} \times \frac{60 \text{ s}}{\cancel{\text{min}}} &= 31\,536\,000 \frac{\text{s}}{\text{y}} \\
 &= 31\,536\,000 \text{ s y}^{-1} \\
 &\approx 3 \times 10^7 \text{ s y}^{-1} \\
 &\approx 30 \text{ million s y}^{-1}
 \end{aligned}$$

```

1
2 How many seconds are in a non-leap year that does not have any leap seconds?
3 % I tried several things and could not get \cancel to work with \per.
4 % Mark Senn 2019-12-29
5 \begin{align*}
6 \quad \frac{\SI{365}{\cancel{d}}{\si{y}}}{
7 \quad \times \frac{\SI{24}{\cancel{h}}{\si{\cancel{d}}}}{
8 \quad \times \frac{\SI{60}{\cancel{min}}{\si{\cancel{h}}}}{
9 \quad \times \frac{\SI{60}{\s}}{\si{\cancel{min}}}}
10 % From http://www.emerson.emory.edu/services/latex/latex_119.html
11 % Spacing in Math Mode
12 % In a math environment, LaTeX ignores the spaces you type
13 % and puts in the spacing that it thinks is best. LaTeX formats
14 % mathematics the way it's done in mathematics texts. If you
15 % want different spacing, LaTeX provides the following four
16 % commands for use in math mode:
17 % \; - a thick space
18 % \: - a medium space
19 % \, - a thin space
20 % \! - a negative thin space
21 & = \num{31536000}\; \frac{\si{\s}}{\si{y}} \\
22 & = \SI{31536000}{\s\per y} \\
23 & \approx \SI{3e7}{\s\per y} \\
24 & \approx \text{30 million}\, \si{\s\per y} \\
25 \end{align*}

```

N.4 Binary Prefixes

```

1
2 \section{Binary Prefixes}

```

The `\kibi ... \yobi` commands are defined immediately after the `\usepackage{siunitx}` command in the `PurdueThesis.cls` file.

```

1
2 The \verb+\kibi+ \ldots \verb+\yobi+
3 commands are defined immediately after the \verb+\usepackage{siunitx}+ command
4 in the PurdueThesis.cls file.

```

Power	Prefix	Symbol	Command	Comment
10	kibi	Ki	<code>\si{\kibi}</code>	2^{10} bytes is a KB, 10^3 bytes is a KiB
20	mebi	Mi	<code>\si{\mebi}</code>	2^{20} bytes is a MB, 10^6 bytes is a MiB
30	gibi	Gi	<code>\si{\gibi}</code>	2^{30} bytes is a GB, 10^9 bytes is a GiB
40	tebi	Ti	<code>\si{\tebi}</code>	2^{40} bytes is a TB, 10^{12} bytes is a TiB
50	pebi	Pi	<code>\si{\pebi}</code>	2^{50} bytes is a PB, 10^{15} bytes is a PiB
60	exbi	Ei	<code>\si{\exbi}</code>	2^{60} bytes is a EB, 10^{18} bytes is a EiB
70	zebi	Zi	<code>\si{\zebi}</code>	2^{70} bytes is a ZB, 10^{21} bytes is a ZiB
80	yobi	Yi	<code>\si{\yobi}</code>	2^{80} bytes is a YB, 10^{24} bytes is a YiB

```

1
2 \newcolumntype{m}{>{\$}r<{\$}} % math mode version of "r" column type
3 \renewcommand{\t}[4]{\(\!^{#1}\) bytes is a #2, \(\!^{#3}\) bytes is a #4}
4 \begin{tabular}{@{}mllll@{}}
5 \multicolumn{1}{l}{\bfseries Power}& & & & \\
6 \bfseries Prefix& & & & \\
7 \bfseries Symbol& & & &

```

```

8     \bfseries Command&
9     \bfseries Comment\\
10    \tabularspace
11    10& kibi& \unit{\kibi\nounit}& \verb+\si{\kibi}+& \t{10}{KB}{3}{KiB}\\
12    20& mebi& \unit{\mebi\nounit}& \verb+\si{\mebi}+& \t{20}{MB}{6}{MiB}\\
13    30& gibi& \unit{\gibi\nounit}& \verb+\si{\gibi}+& \t{30}{GB}{9}{GiB}\\
14    40& tebi& \unit{\tebi\nounit}& \verb+\si{\tebi}+& \t{40}{TB}{12}{TiB}\\
15    50& pebi& \unit{\pebi\nounit}& \verb+\si{\pebi}+& \t{50}{PB}{15}{PiB}\\
16    60& exbi& \unit{\exbi\nounit}& \verb+\si{\exbi}+& \t{60}{EB}{18}{EiB}\\
17    70& zebi& \unit{\zebi\nounit}& \verb+\si{\zebi}+& \t{70}{ZB}{21}{ZiB}\\
18    80& yobi& \unit{\yobi\nounit}& \verb+\si{\yobi}+& \t{80}{YB}{24}{YiB}\\
19    \end{tabular}

```

N.5 Decimal Prefixes

```

1
2 \section{Decimal Prefixes}

```

Power	Prefix	Symbol	Command	Comment
-24	yocto	y	<code>\si{\yocto}</code>	
-21	zepto	z	<code>\si{\zepto}</code>	
-18	atto	a	<code>\si{\atto}</code>	
-15	femto	f	<code>\si{\femto}</code>	
-12	pico	p	<code>\si{\pico}</code>	
-9	nano	n	<code>\si{\nano}</code>	
-6	micro	μ	<code>\si{\micro}</code>	
-3	milli	m	<code>\si{\milla}</code>	
-2	centi	c	<code>\si{\centi}</code>	
-1	deci	d	<code>\si{\deci}</code>	
1	deca	da	<code>\si{\deca}</code>	
1	deka	da	<code>\si{\deka}</code>	same as <code>\si{\deca}</code>
2	hecto	h	<code>\si{\hecto}</code>	
3	kilo	k	<code>\si{\kilo}</code>	
6	mega	M	<code>\si{\mega}</code>	
9	giga	G	<code>\si{\giga}</code>	
12	tera	T	<code>\si{\tera}</code>	
15	peta	P	<code>\si{\peta}</code>	
18	exa	E	<code>\si{\exa}</code>	
21	zetta	Z	<code>\si{\zetta}</code>	
24	yotta	Y	<code>\si{\yotta}</code>	

```

1
2 \newcolumnntype{m}{>{\$}r<{\$}} % math mode version of "r" column type
3 \begin{tabular}{@{}mllll@{}}
4   \multicolumn{1}{l}{\bfseries Power}&&&&
5   \bfseries Prefix&&&&
6   \bfseries Symbol&&&&
7   \bfseries Command&&&&
8   \bfseries Comment\\
9 \tabularspace
10 -24& yocto& \unit{\yocto\nounit}& \verb+\si{\yocto}+\\
11 -21& zepto& \unit{\zepto\nounit}& \verb+\si{\zepto}+\\

```

```

12 -18& atto& \unit{\atto\nounit}& \verb+\si{\atto}+\
13 -15& femto& \unit{\femto\nounit}& \verb+\si{\femto}+\
14 -12& pico& \unit{\pico\nounit}& \verb+\si{\pico}+\
15 -9& nano& \unit{\nano\nounit}& \verb+\si{\nano}+\
16 -6& micro& \unit{\micro\nounit}& \verb+\si{\micro}+\
17 -3& milli& \unit{\milli\nounit}& \verb+\si{\milla}+\
18 -2& centi& \unit{\centi\nounit}& \verb+\si{\centi}+\
19 -1& deci& \unit{\deci\nounit}& \verb+\si{\deci}+\
20 1& deca& \unit{\deca\nounit}& \verb+\si{\deca}+\
21 1& deka& \unit{\deka\nounit}& \verb+\si{\deka}+& same as \verb+\si{\deca}+\
22 2& hecto& \unit{\hecto\nounit}& \verb+\si{\hecto}+\
23 3& kilo& \unit{\kilo\nounit}& \verb+\si{\kilo}+\
24 6& mega& \unit{\mega\nounit}& \verb+\si{\mega}+\
25 9& giga& \unit{\giga\nounit}& \verb+\si{\giga}+\
26 12& tera& \unit{\tera\nounit}& \verb+\si{\tera}+\
27 15& peta& \unit{\peta\nounit}& \verb+\si{\peta}+\
28 18& exa& \unit{\exa\nounit}& \verb+\si{\exa}+\
29 21& zetta& \unit{\zetta\nounit}& \verb+\si{\zetta}+\
30 24& yotta& \unit{\yotta\nounit}& \verb+\si{\yotta}+\
31 \end{tabular}

```

N.6 SI Units

```

1
2 \section{SI Units}

```

The International System of Units (SI) is the modern form of the metric system. There are seven SI base units:

Name	Unit Of	Symbol
ampere	electrical current	A
candela	luminous intensity	cd
kelvin	thermodynamic temperature	K
kg	mass	kg
meter	length	m
mole	amount of substance	mol
second	time	s

```

1
2 The International System of Units
3 (SI)
4 % !!! Doing
5 % !!! \include{tipa}
6 % !!! in thesis.tex so \textprimstress works
7 % !!! apparently causes problems with math commands.
8 % !!! Figure out why the following doesn't work later.
9 % (
10 % SI,
11 % abbreviated from the French Syst\`eme International
12 % (d\textprimstress unit\`es)%
13 % )
14 is the modern form of the metric system.
15 There are seven SI base units:
16
17 \hspace{40pt}
18 \begin{tabular}{@{}l1l1@{}}
19 \tabularspace
20 \bfseries Name& \bfseries Unit Of& \bfseries Symbol\

```

```

21 \tabularspace
22 ampere& electrical current& \si{\ampere}\\
23 candela& luminous intensity& \si{\candela}\\
24 kelvin& thermodynamic temperature& \si{\kelvin}\\
25 kg& mass& \si{\kilogram}\\
26 meter& length& \si{\meter}\\
27 mole& amount of substance& \si{\mole}\\
28 second& time& \si{\second}\\
29 \end{tabular}

```

N.7 Complete List of Units

```

1
2 \section{Complete List of Units}
3 \label{se:Complete-List-of-Units}

```

Table N.1. Units and Corresponding Symbols

Name	Unit Of	Symbol	Command	Is equal to
ampere	electrical current	A	<code>\si{\A}</code>	(SI base unit)
picoampere	"	pA	<code>\si{\pA}</code>	10^{-12} A
nanoampere	"	nA	<code>\si{\nA}</code>	10^{-9} A
microampere	"	μ A	<code>\si{\uA}</code>	10^{-6} A
milliampere	"	mA	<code>\si{\mA}</code>	10^{-3} A
kiloampere	"	kA	<code>\si{\kA}</code>	10^3 A
arcminute	plane angle	'	<code>\si{\arcmin}</code>	$1/60^\circ$
arcsecond	plane angle	"	<code>\si{\arcsec}</code>	$1/60'$
astronomical unit	length	au	<code>\si{\au}</code>	mean earth to sun distance
bar	pressure	bar	<code>\si{\bar}</code>	10^{-5} Pa
millibar	"	mbar	<code>\si{\mbar}</code>	10^{-3} bar
barn	area	b	<code>\si{\b}</code>	10^{-28} m ²
becquerel	radioactivity	Bq	<code>\si{\Bq}</code>	one radioactive decay per second
bel	sound intensity	B	<code>\si{\B}</code>	10 decibels

continued on next page

Table N.1. *continued*

Name	Unit Of	Symbol	Command	Is equal to
decibel	"	dB	<code>\si{\dB}</code>	10^{-1} B
bohr	length	a_0	<code>\si{\bohr}</code>	distance between nucleus and electron in hydrogen atom
bushel	quantity	bu	<code>\si{\bu}</code>	see [31]
candela	luminous intensity	cd	<code>\si{\cd}</code>	(SI base unit)
coulomb	electrical charge	C	<code>\si{\C}</code>	$A s^{-1}$
dalton	mass	Da	<code>\si{\Da}</code>	another name for atomic mass unit
day	time	d	<code>\si{\d}</code>	86 400 s
degree	plane angle	°	<code>\si{\degree}</code>	1/360 of a circle
degree Celsius	temperature	°C	<code>\si{\celsius}</code>	xxx
electron mass	mass	m_e	<code>\si{\em}</code>	xxx
electronvolt	energy	eV	<code>\si{\eV}</code>	xxx
millielectronvolt	"	meV	<code>\si{meV}</code>	10^{-3} eV
kiloelectronvolt	"	keV	<code>\si{keV}</code>	10^3 eV
megaelectronvolt	"	MeV	<code>\si{MeV}</code>	10^6 eV
gigaelectronvolt	"	GeV	<code>\si{GeV}</code>	10^9 eV
teraelectronvolt	"	TeV	<code>\si{TeV}</code>	10^{12} eV
elementary charge	electrical charge	e	<code>\si{ec}</code>	$\approx 1.6 \times 10^{19}$ C
farad	electrical capacitance	F	<code>\si{F}</code>	$s^4 A^2 m^{-2} kg^{-1}$
femtofarad	"	fF	<code>\si{fF}</code>	10^{-15} F

continued on next page

Table N.1. *continued*

Name	Unit Of	Symbol	Command	Is equal to
picofarad	"	pF	<code>\si{\pF}</code>	10^{-12} F
foot	length	ft	<code>\si{\ft}</code>	0.3048 m
gray	absorbed dose of ionizing radiation	Gy	<code>\si{\Gy}</code>	J kg^{-1}
hartree	energy used in molecular orbital calculations	E_h	<code>\si{\hartree}</code>	xxx
hectare	area	ha	<code>\si{\ha}</code>	10^4 m ²
henry	electrical inductance	H	<code>\si{\H}</code>	$\text{kg m}^2 \text{s}^{-2} \text{A}^{-2}$
hertz	frequency	Hz	<code>\si{\Hz}</code>	s^{-1}
millihertz	"	mHz	<code>\si{\mHz}</code>	10^{-3} Hz
kilohertz	"	kHz	<code>\si{\kHz}</code>	10^3 Hz
megahertz	"	MHz	<code>\si{\MHz}</code>	10^6 Hz
gigahertz	"	GHz	<code>\si{\GHz}</code>	10^9 Hz
terahertz	"	THz	<code>\si{\THz}</code>	10^{12} Hz
horsepower	power	hp	<code>\si{\hp}</code>	≈ 745.7 W, IMPORTANT: see Horsepower
hour	time	h	<code>\si{\h}</code>	3600 s
inch	length	in	<code>\si{\in}</code>	25.4 mm
joule	work or energy	J	<code>\si{\J}</code>	$\text{kg m}^2 \text{s}^{-2}$
microjoule	"	μJ	<code>\si{\uJ}</code>	10^{-6} J
millijoule	"	mJ	<code>\si{\mJ}</code>	10^{-3} J
kilojoule	"	kJ	<code>\si{\kJ}</code>	10^3 J
megajoule	"	MJ	<code>\si{\MJ}</code>	10^6 J
katal	catalytic activity	kat	<code>\si{\kat}</code>	mol s^{-1}
kelvin	thermody- namic temperature	K	<code>\si{\K}</code>	(SI base unit)
kilogram	mass	kg	<code>\si{\kg}</code>	(SI base unit)

continued on next page

Table N.1. *continued*

Name	Unit Of	Symbol	Command	Is equal to
femtogram	"	fg	<code>\si{\fg}</code>	10^{-15} g
picogram	"	pg	<code>\si{\pg}</code>	10^{-12} g
nanogram	"	ng	<code>\si{\ng}</code>	10^{-9} g
microgram	"	µg	<code>\si{\ug}</code>	10^{-6} g
milligram	"	mg	<code>\si{\mg}</code>	10^{-3} g
gram	"	g	<code>\si{\g}</code>	10^{-3} kg
kilowatt hour	electrical energy	kWh	<code>\si{\kWh}</code>	kW h
knot	speed	kn	<code>\si{\kn}</code>	M h^{-1}
liter	volume	L	<code>\si{\L}</code>	10^{-3} m ³
microliter	"	µL	<code>\si{\uL}</code>	10^{-6} L
milliliter	"	mL	<code>\si{\mL}</code>	10^{-3} L
hectoliter	"	hL	<code>\si{\hL}</code>	10^2 L
lumen	luminous flux	lm	<code>\si{\lm}</code>	cd sr
lux	illumination	lx	<code>\si{\lx}</code>	lm m^{-2}
meter	length	m	<code>\si{\m}</code>	(SI base unit)
picometer	"	pm	<code>\si{\pm}</code>	10^{-12} m
nanometer	"	nm	<code>\si{\nm}</code>	10^{-9} m
micrometer	"	µm	<code>\si{\um}</code>	10^{-6} m
millimeter	"	mm	<code>\si{\mm}</code>	10^{-3} m
centimeter	"	cm	<code>\si{\cm}</code>	10^{-2} m
decimeter	"	dm	<code>\si{\dm}</code>	10^{-1} m
kilometer	"	km	<code>\si{\km}</code>	10^3 m
millimeter of mercury	pressure	mmHg	<code>\si{\mmHg}</code>	≈ 133 Pa
minute	time	min	<code>\si{\min}</code>	60 s
mole	amount of substance	mol	<code>\si{\mol}</code>	(SI base unit)
femtomole	"	fmol	<code>\si{\fmol}</code>	10^{-15} mol
picomole	"	pmol	<code>\si{\pmol}</code>	10^{-12} mol
nanomole	"	nmol	<code>\si{\nmol}</code>	10^{-9} mol
micromole	"	µmol	<code>\si{\umol}</code>	10^{-6} mol
millimole	"	mmol	<code>\si{\mmol}</code>	10^{-3} mol

continued on next page

Table N.1. *continued*

Name	Unit Of	Symbol	Command	Is equal to
kilomole	"	kmol	<code>\si{\kmol}</code>	10^3 mol
nautical mile	distance	M	<code>\si{\M}</code>	1852 m
neper	gain, loss, and relative values	Np	<code>\si{\Np}</code>	1
newton	force	N	<code>\si{\N}</code>	kg m s^{-2}
millinewton	"	mN	<code>\si{\mN}</code>	10^{-3} N
kilonewton	"	kN	<code>\si{\kN}</code>	10^3 N
meganewton	"	MN	<code>\si{\MN}</code>	10^6 N
ohm	electrical resistance	Ω	<code>\si{\ohm}</code>	$\text{kg m}^2 \text{s}^{-3} \text{A}^{-2}$
milliohm	"	$\text{m}\Omega$	<code>\si{\mohm}</code>	10^{-3} ohm
kiloohm	"	$\text{k}\Omega$	<code>\si{\kohm}</code>	10^3 ohm
megaohm	"	$\text{M}\Omega$	<code>\si{\Mohm}</code>	10^6 ohm
pascal	pressure	Pa	<code>\si{\Pa}</code>	$\text{kg m}^{-1} \text{s}^{-2}$
kilopascal	"	kPa	<code>\si{\kPa}</code>	10^3 Pa
megapascal	"	MPa	<code>\si{\MPa}</code>	10^6 Pa
gigapascal	"	GPa	<code>\si{\GPa}</code>	10^9 Pa
percent	hundredths	%	<code>\si{\percent}</code>	10^{-2}
pound	weight	lb	<code>\si{\lb}</code>	0.453 592 37 kg
radian	plane angular measurement	rad	<code>\si{\rad}</code>	$180/\pi$ °
reduced Planck constant	angular momentum	\hbar	<code>\si{\planckbar}</code>	$\approx 1.05 \times 10^{-34}$ J s
second	time	s	<code>\si{\s}</code>	(SI base unit)
attosecond	"	as	<code>\si{\as}</code>	10^{-18} s
femtosecond	"	fs	<code>\si{\fs}</code>	10^{-15} s
picosecond	"	ps	<code>\si{\ps}</code>	10^{-12} s
nanosecond	"	ns	<code>\si{\ns}</code>	10^{-9} s
microsecond	"	μs	<code>\si{\us}</code>	10^{-6} s

continued on next page

Table N.1. *continued*

Name	Unit Of	Symbol	Command	Is equal to
millisecond	"	ms	<code>\si{\ms}</code>	10^{-3} s
siemens	conductance	S	<code>\si{\S}</code>	$\text{kg}^{-1} \text{ m}^{-2} \text{ s}^3 \text{ A}^2$
sievert	dosage of ionizing radiation	Sv	<code>\si{\Sv}</code>	$\text{m}^2 \text{ s}^{-2}$
speed of light	speed	c_0	<code>\si{\cflight}</code>	$299\,792\,458 \text{ m s}^{-1}$
standard deviation	amount of variation	SD	<code>\si{\SD}</code>	$\sqrt{\frac{1}{N-1} \sum_{i=1}^N (x_i - \bar{x})^2}$
steradian	measure of solid angles	sr	<code>\si{\sr}</code>	$1 \text{ m}^2 \text{ m}^{-2}$
tesla	magnetic flux density	T	<code>\si{\T}</code>	$\text{kg s}^{-2} \text{ A}^{-1}$
metric ton	mass	t	<code>\si{\t}</code>	10^3 kg
volt	electrical potential difference	V	<code>\si{\V}</code>	$\text{kg m}^2 \text{ s}^{-3} \text{ A}^{-1}$
picovolt	"	pV	<code>\si{\pV}</code>	10^{-12} V
nanovolt	"	nV	<code>\si{\nV}</code>	10^{-9} V
microvolt	"	μV	<code>\si{\uV}</code>	10^{-6} V
millivolt	"	mV	<code>\si{\mV}</code>	10^{-3} V
kilovolt	"	kV	<code>\si{\kV}</code>	10^3 V
watt	power	W	<code>\si{\W}</code>	$\text{kg m}^2 \text{ s}^{-3}$
microwatt	"	μW	<code>\si{\uW}</code>	10^{-6} W
milliwatt	"	mW	<code>\si{\mW}</code>	10^{-3} W
kilowatt	"	kW	<code>\si{\kW}</code>	10^3 W
megawatt	"	MW	<code>\si{\MW}</code>	10^6 W
gigawatt	"	GW	<code>\si{\GW}</code>	10^9 W
weber	magnetic flux	Wb	<code>\si{\Wb}</code>	$\text{kg m}^2 \text{ s}^{-2} \text{ A}^{-1}$
yard	length	yd	<code>\si{\yd}</code>	0.9144 m
year	time	y	<code>\si{\y}</code>	$\approx 365.25 \text{ d}$

```

1
2 {%
3 \ZZbaselinestretch{1}
4 \newcommand\vsp{\noalign{\vspace*{6pt}}}
5 % From
6 % https://tex.stackexchange.com/questions/31508/flushleft-with-p-option-in-tabular
7 % It's necessary to use the \arraybackslash in the last column,

```

```

8 % otherwise \\ would not end the table row. You can use \newline
9 % to end lines in the last column cells (and the regular \\ in
10 % the other column cells).
11 % ...
12 % If you need it often, consider defining a new column type using
13 % array features, as I did here:
14 % \newcolumntype{P}[1]{>{\raggedright\arraybackslash}p{#1}}
15 \newcolumntype{P}[1]{>{\raggedright\arraybackslash}p{#1}}%
16 % \begin{longtable}{@{}P{1.4in}P{1in}lP{1.8in}@{}}
17 % \begin{longtable}{@{}P{1in}P{1in}lP{1.8in}@{}}
18 % \begin{longtable}{@{}P{1.2in}P{1in}lP{1.8in}@{}}
19 % \begin{longtable}{@{}P{90.72pt}P{1in}lP{1.8in}@{}} % 1.2in (86.72pt) + 4pt = 90.72pt
20 \begin{longtable}{@{}P{1.4in}P{1in}lP{1.8in}@{}}% 1.2in (86.72pt) + 4pt = 90.72pt
21 \caption{Units and Corresponding Symbols}\\
22 \bfseries Name&
23 \bfseries Unit Of&
24 \bfseries Symbol&
25 \bfseries Command&
26 \bfseries Is equal to\\
27 \vsp
28 \endfirsthead
29 \caption[{}]{~\emph{continued}}\\
30 \bfseries Name&
31 \bfseries Unit Of&
32 \bfseries Symbol&
33 \bfseries Command&
34 \bfseries Is equal to\\
35 \vsp
36 \endhead
37 \vsp
38 % I don't know why the \hspace*{-7.5mm} was
39 % needed to center this horizontally.
40 \multicolumn{5}{@{}c@{}}{\hspace*{-7.5mm}\emph{continued on next page}}%
41 \endfoot
42 \endlastfoot
43 ampere&
44 electrical current&
45 \si{A}&
46 \verb+\si{A}+&
47 (SI base unit)\\
48 \quad picoampere&
49 \ditto&
50 \si{pA}&
51 \verb+\si{pA}+&
52 \SI{e-12}{A}\\
53 \quad nanoampere&
54 \ditto&
55 \si{nA}&
56 \verb+\si{nA}+&
57 \SI{e-9}{A}\\
58 \quad microampere&
59 \ditto&
60 \si{uA}&
61 \verb+\si{uA}+&
62 \SI{e-6}{A}\\
63 \quad milliampere&
64 \ditto&
65 \si{mA}&
66 \verb+\si{mA}+&
67 \SI{e-3}{A}\\
68 \quad kiloampere&
69 \ditto&
70 \si{kA}&
71 \verb+\si{kA}+&

```

```

72     \SI{e3}{\A}\
73 \vsp
74 % \aa ngstr"om&
75 % length&
76 % \si{\AA}&
77 % \verb+\si{\AA}+&
78 % \SI{e-10}{\m}\
79 \vsp
80 arcminute&
81 plane angle&
82 \si{\arcmin}&
83 \verb+\si{\arcmin}+&
84 % Changed
85 % \SI{1/60}{\degree}\
86 % to
87 1/60\unit{\degree\nounit}\
88 arcsecond&
89 plane angle&
90 \si{\arcsec}&
91 \verb+\si{\arcsec}+&
92 % Changed
93 % \SI{1/60}{\arcmin}\
94 % to
95 1/60\unit{\arcmin\nounit}\
96 \vsp
97 astronomical unit&
98 length&
99 \si{\au}&
100 \verb+\si{\au}+&
101 mean earth to\newline sun distance\
102 \vsp
103 % From
104 % siunitx - A comprehensive (SI) units package
105 % Joseph Wright
106 % Released 2021-08-04
107 % (this describes v3.0.24, last revised 2021-08-04)
108 % https://mirror.las.iastate.edu/tex-archive/macros/latex/contrib/siunitx/siunitx.pdf
109 % page 51:
110 % ...the unit \atomicmassunit has similar deprecated status:
111 % this was listed as with experimentally-determined units
112 % in the 8th Edition of the si Brochure but is equivalent
113 % to the dalton, a unit which remains accepted.
114 % atomic mass unit&
115 % mass&
116 % \si{\amu}&
117 % \verb+\si{\amu}+&
118 % \SI{(1/12)}{mass of\newline carbon-12 atom}\
119 % \vsp
120 bar&
121 pressure&
122 \si{\bar}&
123 \verb+\si{\bar}+&
124 \SI{e-5}{\Pa}\
125 \quad millibar&
126 \ditto&
127 \si{\mbar}&
128 \verb+\si{\mbar}+&
129 \SI{e-3}{\bar}\
130 \vsp
131 barn&
132 area&
133 \si{\b}&
134 \verb+\si{\b}+&
135 \SI{e-28}{\m\squared}\

```

```

136 \vsp
137 becquerel&
138   radioactivity&
139   \si{\Bq}&
140   \verb+\si{\Bq}+&
141   one radioactive\newline decay per second\\
142 \vsp
143 bel&
144   sound intensity&
145   \si{\B}&
146   \verb+\si{\B}+&
147   10 decibels\\
148 \quad decibel&
149   \ditto&
150   \si{\dB}&
151   \verb+\si{\dB}+&
152   \SI{e-1}{\B}\\
153 \vsp
154 bohr&
155   length&
156   \si{\bohr}&
157   \verb+\si{\bohr}+&
158   distance between\newline nucleus and electron\newline in hydrogen atom\\
159 \vsp
160 bushel&
161   quantity&
162   \si{\bu}&
163   \verb+\si{\bu}+&
164   see \cite{wikipedia-bushel}\\
165 \vsp
166 candela&
167   luminous intensity&
168   \si{\cd}&
169   \verb+\si{\cd}+&
170   (SI base unit)\\
171 \vsp
172 coulomb&
173   electrical charge&
174   \si{\C}&
175   \verb+\si{\C}+&
176   \si{\A\per\s}\\
177 \vsp
178 dalton&
179   mass&
180   \si{\Da}&
181   \verb+\si{\Da}+&
182   another name for\newline atomic mass unit\\
183 \vsp
184 day&
185   time&
186   \si{\d}&
187   \verb+\si{\d}+&
188   \SI{86400}{\s}\\
189 \vsp
190 degree&
191   plane angle&
192   \si{\degree}&
193   \verb+\si{\degree}+&
194   1/360 of a cicle\\
195 \vsp
196 degree Celsius&
197   temperature&
198   \si{\celsius}&
199   \verb+\si{\celsius}+&

```

```

200     xxx\\
201 \vsp
202 electron mass&
203     mass&
204     \si{\em}&
205     \verb+\si{\em}+&
206     xxx\\
207 \vsp
208 electronvolt&
209     energy&
210     \si{\eV}&
211     \verb+\si{\eV}+&
212     xxx\\
213 \quad millielectronvolt&
214     \ditto&
215     \si{\meV}&
216     \verb+\si{meV}+&
217     \SI{e-3}{\eV}\\
218 \quad kiloelectronvolt&
219     \ditto&
220     \si{\keV}&
221     \verb+\si{keV}+&
222     \SI{e3}{\eV}\\
223 \quad megaelectronvolt&
224     \ditto&
225     \si{\MeV}&
226     \verb+\si{MeV}+&
227     \SI{e6}{\eV}\\
228 \quad gigaelectronvolt&
229     \ditto&
230     \si{\GeV}&
231     \verb+\si{\GeV}+&
232     \SI{e9}{\eV}\\
233 \quad teraelectronvolt&
234     \ditto&
235     \si{\TeV}&
236     \verb+\si{\TeV}+&
237     \SI{e12}{\eV}\\
238 \vsp
239 elementary charge&
240     electrical charge&
241     \si{\ec}&
242     \verb+\si{\ec}+&
243     \href{https://en.wikipedia.org/wiki/Elementary_charge}{\SI{\approx 1.6e19}{\C}}\\
244 \vsp
245 farad&
246     electrical capacitance&
247     \si{\F}&
248     \verb+\si{\F}+&
249     \si{\s\tothe{4}\A\squared\per\m\squared\per\kg}\\
250 \quad femtofarad&
251     \ditto&
252     \si{\fF}&
253     \verb+\si{\fF}+&
254     \SI{e-15}{\F}\\
255 \quad picofarad&
256     \ditto&
257     \si{\pF}&
258     \verb+\si{\pF}+&
259     \SI{e-12}{\F}\\
260 \vsp
261 foot&
262     length&
263     \si{\ft}&

```



```

264     \verb+\si{ft}+&
265     \SI{0.3048}{m}\ % not an SI unit
266 \vsp
267 % gauss: The gauss, symbol G, sometimes Gs, is the cgs unit of measurement of magnetic flux.
268 gray&
269     absorbed dose of ionizing radiation&
270     \si{Gy}&
271     \verb+\si{Gy}+&
272     \si{J\per\kg}\
273 \vsp
274 hartree&
275     energy used in molecular orbital calculations&
276     \si{hartree}&
277     \verb+\si{hartree}+&
278     xxx\
279 \vsp
280 hectare&
281     area&
282     \si{ha}&
283     \verb+\si{ha}+&
284     \SI{e4}{m\squared}\
285 \vsp
286 henry&
287     electrical inductance&
288     \si{H}&
289     \verb+\si{H}+&
290     \si{kg\m\squared\per\s\squared\per\A\squared}\
291 \vsp
292 hertz&
293     frequency&
294     \si{Hz}&
295     \verb+\si{Hz}+&
296     \si{\per\s}\
297 \quad millihertz&
298     \ditto&
299     \si{mHz}&
300     \verb+\si{mHz}+&
301     \SI{e-3}{Hz}\
302 \quad kilohertz&
303     \ditto&
304     \si{kHz}&
305     \verb+\si{kHz}+&
306     \SI{e3}{Hz}\
307 \quad megahertz&
308     \ditto&
309     \si{MHz}&
310     \verb+\si{MHz}+&
311     \SI{e6}{Hz}\
312 \quad gigahertz&
313     \ditto&
314     \si{GHz}&
315     \verb+\si{GHz}+&
316     \SI{e9}{Hz}\
317 \quad terahertz&
318     \ditto&
319     \si{THz}&
320     \verb+\si{THz}+&
321     \SI{e12}{Hz}\
322 \vsp
323 horsepower&
324     power&
325     \si{hp}&
326     \verb+\si{hp}+&
327     \SI{\approx 745.7}{W}, {\bfseries IMPORTANT:\newline

```

```

328         see \href{https://en.wikipedia.org/wiki/Horsepower#Mechanical_horsepower}{Horsepower}}\
329         % not an SI unit
330     \vsp
331     hour&
332         time&
333         \si{\h}&
334         \verb+\si{\h}+&
335         \SI{3600}{\s}\
336     \vsp
337     inch&
338         length&
339         \si{\in}&
340         \verb+\si{\in}+&
341         \SI{25.4}{\mm}\ % not an SI unit
342     \vsp
343     joule&
344         work or energy&
345         \si{\J}&
346         \verb+\si{\J}+&
347         \si{\kg\m\squared\per\s\squared}\
348     \quad microjoule&
349         \ditto&
350         \si{\uJ}&
351         \verb+\si{\uJ}+&
352         \SI{e-6}{\J}\
353     \quad millijoule&
354         \ditto&
355         \si{\mJ}&
356         \verb+\si{\mJ}+&
357         \SI{e-3}{\J}\
358     \quad kilojoule&
359         \ditto&
360         \si{\kJ}&
361         \verb+\si{\kJ}+&
362         \SI{e3}{\J}\
363     \quad megajoule&
364         \ditto&
365         \si{\MJ}&
366         \verb+\si{\MJ}+&
367         \SI{e6}{\J}\
368     \vsp
369     katal&
370         catalytic activity&
371         \si{\kat}&
372         \verb+\si{\kat}+&
373         \si{\mol\per\s}\
374     \vsp
375     kelvin&
376         thermodynamic temperature&
377         \si{\K}&
378         \verb+\si{\K}+&
379         (SI base unit)\
380     \vsp
381     kilogram&
382         mass&
383         \si{\kg}&
384         \verb+\si{\kg}+&
385         (SI base unit)\
386     \quad femtogram&
387         \ditto&
388         \si{\fg}&
389         \verb+\si{\fg}+&
390         \SI{e-15}{\g}\
391     \quad picogram&

```

```

392     \ditto&
393     \si{\pg}&
394     \verb+\si{\pg}+&
395     \SI{e-12}{\g}\l
396 \quad nanogram&
397     \ditto&
398     \si{\ng}&
399     \verb+\si{\ng}+&
400     \SI{e-9}{\g}\l
401 \quad microgram&
402     \ditto&
403     \si{\ug}&
404     \verb+\si{\ug}+&
405     \SI{e-6}{\g}\l
406 \quad milligram&
407     \ditto&
408     \si{\mg}&
409     \verb+\si{\mg}+&
410     \SI{e-3}{\g}\l
411 \quad gram&
412     \ditto&
413     \si{\g}&
414     \verb+\si{\g}+&
415     \SI{e-3}{\kg}\l
416 \vsp
417 kilowatt hour&
418     electrical energy&
419     \si{\kWh}&
420     \verb+\si{\kWh}+&
421     \si{\kW\h}\l
422 \vsp
423 knot&
424     speed&
425     \si{\kn}&
426     \verb+\si{\kn}+&
427     \si{M\per\h}\l
428 \vsp
429 liter&
430     volume&
431     \si{\L}&
432     \verb+\si{\L}+&
433     \SI{e-3}{m\cubed}\l
434 \quad microliter&
435     \ditto&
436     \si{\uL}&
437     \verb+\si{\uL}+&
438     \SI{e-6}{\L}\l
439 \quad milliliter&
440     \ditto&
441     \si{\mL}&
442     \verb+\si{\mL}+&
443     \SI{e-3}{\L}\l
444 \quad hectoliter&
445     \ditto&
446     \si{\hL}&
447     \verb+\si{\hL}+&
448     \SI{e2}{\L}\l
449 \vsp
450 lumen&
451     luminous flux&
452     \si{\lm}&
453     \verb+\si{\lm}+&
454     \si{\cd\sr}\l
455 \vsp

```

```

456 lux&
457 illumination&
458 \si{\lx}&
459 \verb+\si{\lx}+&
460 \si{\lm\per\m\squared}\\
461 \vsp
462 meter&
463 length&
464 \si{\m}&
465 \verb+\si{\m}+&
466 (SI base unit)\\
467 \quad picometer&
468 \ditto&
469 \si{\pm}&
470 \verb+\si{\pm}+&
471 \SI{e-12}{\m}\\
472 \quad nanometer&
473 \ditto&
474 \si{\nm}&
475 \verb+\si{\nm}+&
476 \SI{e-9}{\m}\\
477 \quad micrometer&
478 \ditto&
479 \si{\um}&
480 \verb+\si{\um}+&
481 \SI{e-6}{\m}\\
482 \quad millimeter&
483 \ditto&
484 \si{\mm}&
485 \verb+\si{\mm}+&
486 \SI{e-3}{\m}\\
487 \quad centimeter&
488 \ditto&
489 \si{\cm}&
490 \verb+\si{\cm}+&
491 \SI{e-2}{\m}\\
492 \quad decimeter&
493 \ditto&
494 \si{\dm}&
495 \verb+\si{\dm}+&
496 \SI{e-1}{\m}\\
497 \quad kilometer&
498 \ditto&
499 \si{\km}&
500 \verb+\si{\km}+&
501 \SI{e3}{\m}\\
502 \vsp
503 % mile: not an SI unit
504 millimeter of mercury&
505 pressure&
506 \si{\mmHg}&
507 \verb+\si{\mmHg}+&
508 \href{https://en.wikipedia.org/wiki/Millimetre_of_mercury}{\SI{\approx 133}{\Pa}}\\
509 \vsp
510 minute&
511 time&
512 \si{\min}&
513 \verb+\si{\min}+&
514 \SI{60}{\s}\\
515 \vsp
516 mole&
517 amount of substance&
518 \si{\mol}&
519 \verb+\si{\mol}+&

```

```

520     (SI base unit)\
521 \quad femtomole&
522     \ditto&
523     \si{\fmol}&
524     \verb+\si{\fmol}+&
525     \SI{e-15}{\mol}\
526 \quad picomole&
527     \ditto&
528     \si{\pmol}&
529     \verb+\si{\pmol}+&
530     \SI{e-12}{\mol}\
531 \quad nanomole&
532     \ditto&
533     \si{\nmol}&
534     \verb+\si{\nmol}+&
535     \SI{e-9}{\mol}\
536 \quad micromole&
537     \ditto&
538     \si{\umol}&
539     \verb+\si{\umol}+&
540     \SI{e-6}{\mol}\
541 \quad millimole&
542     \ditto&
543     \si{\mmol}&
544     \verb+\si{\mmol}+&
545     \SI{e-3}{\mol}\
546 \quad kilomole&
547     \ditto&
548     \si{\kmol}&
549     \verb+\si{\kmol}+&
550     \SI{e3}{\mol}\
551 \vsp
552 nautical mile&
553     distance&
554     \si{\M}&
555     \verb+\si{\M}+&
556     \SI{1852}{\m}\
557 \vsp
558 neper&
559     gain, loss, and relative values&
560     \si{\Np}&
561     \verb+\si{\Np}+&
562     1\
563 \vsp
564 newton&
565     force&
566     \si{\N}&
567     \verb+\si{\N}+&
568     \si{\kg\m\per\s\squared}\
569 \quad millinewton&
570     \ditto&
571     \si{\mN}&
572     \verb+\si{\mN}+&
573     \SI{e-3}{\N}\
574 \quad kilonewton&
575     \ditto&
576     \si{\kN}&
577     \verb+\si{\kN}+&
578     \SI{e3}{\N}\
579 \quad meganewton&
580     \ditto&
581     \si{\MN}&
582     \verb+\si{\MN}+&
583     \SI{e6}{\N}\

```

```

584 \vsp
585 ohm&
586     electrical resistance&
587     \si{\ohm}&
588     \verb+\si{\ohm}+&
589     \si{\kg\m\squared\per\s\cubed\per\A\squared}\\
590 \quad milliohm&
591     \ditto&
592     \si{\mohm}&
593     \verb+\si{\mohm}+&
594     \SI{e-3}{ohm}\\
595 \quad kiloohm&
596     \ditto&
597     \si{\kohm}&
598     \verb+\si{\kohm}+&
599     \SI{e3}{ohm}\\
600 \quad megaohm&
601     \ditto&
602     \si{\Mohm}&
603     \verb+\si{\Mohm}+&
604     \SI{e6}{ohm}\\
605 \vsp
606 pascal&
607     pressure&
608     \si{\Pa}&
609     \verb+\si{\Pa}+&
610     \si{\kg\per\m\per\s\squared}\\
611 \quad kilopascal&
612     \ditto&
613     \si{\kPa}&
614     \verb+\si{\kPa}+&
615     \SI{e3}{\Pa}\\
616 \quad megapascal&
617     \ditto&
618     \si{\MPa}&
619     \verb+\si{\MPa}+&
620     \SI{e6}{\Pa}\\
621 \quad gigapascal&
622     \ditto&
623     \si{\GPa}&
624     \verb+\si{\GPa}+&
625     \SI{e9}{\Pa}\\
626 \vsp
627 percent&
628     hundredths&
629     \si{\percent}&
630     \verb+\si{\percent}+&
631     \SI{e-2}{}\\
632 \vsp
633 pound&
634     weight&
635     \si{\lb}&
636     \verb+\si{\lb}+&
637     \SI{.45359237}{\kg}\\ % not an SI unit
638 \vsp
639 radian&
640     plane angular measurement&
641     \si{\rad}&
642     \verb+\si{\rad}+&
643     \((180/\pi)\ \unit{\degree\nounit}\\
644 \vsp
645 reduced Planck constant&
646     angular momentum&
647     \si{\planckbar}&

```

```

648     \verb+\si{\planckbar}+&
649     \(\approx \SI{1.05e-34}{\J\s}\)\)\\
650 \vsp
651 second&
652     time&
653     \si{\s}&
654     \verb+\si{\s}+&
655     (SI base unit)\)\\
656 \quad attosecond&
657     \ditto&
658     \si{\as}&
659     \verb+\si{\as}+&
660     \SI{e-18}{\s}\)\\
661 \quad femtosecond&
662     \ditto&
663     \si{\fs}&
664     \verb+\si{\fs}+&
665     \SI{e-15}{\s}\)\\
666 \quad picosecond&
667     \ditto&
668     \si{\ps}&
669     \verb+\si{\ps}+&
670     \SI{e-12}{\s}\)\\
671 \quad nanosecond&
672     \ditto&
673     \si{\ns}&
674     \verb+\si{\ns}+&
675     \SI{e-9}{\s}\)\\
676 \quad microsecond&
677     \ditto&
678     \si{\us}&
679     \verb+\si{\us}+&
680     \SI{e-6}{\s}\)\\
681 \quad millisecond&
682     \ditto&
683     \si{\ms}&
684     \verb+\si{\ms}+&
685     \SI{e-3}{\s}\)\\
686 \vsp
687 siemens&
688     conductance&
689     \si{\S}&
690     \verb+\si{\S}+&
691     \si{\per\kg\per\m\squared\s\cubed\A\squared}\)\\
692 \vsp
693 sievert&
694     dosage of ionizing radiation&
695     \si{\Sv}&
696     \verb+\si{\Sv}+&
697     \si{\m\squared\per\s\squared}\)\\
698 \vsp
699 speed of light&
700     speed&
701     \si{\clight}&
702     \verb+\si{\clight}+&
703     \SI{299792458}{\m\per\s}\)\\
704 \vsp
705 standard deviation&
706     amount of variation&
707     \si{\SD}&
708     \verb+\si{\SD}+&
709     $\displaystyle \sqrt{\frac{1}{N-1} \sum_{i=1}^N (x_i - \bar{x})^2}$\\
710 \vsp
711 steradian&

```

```

712     measure of solid angles&
713     \si{\sr}&
714     \verb+\si{\sr}+&
715     \SI{1}{\m\squared\per\m\squared}\
716 \vsp
717 tesla&
718     magnetic flux density&
719     \si{T}&
720     \verb+\si{T}+&
721     \si{kg\per\s\squared\per\A}\
722 \vsp
723 metric ton&
724     mass&
725     \si{t}&
726     \verb+\si{t}+&
727     \SI{e3}{\kg}\
728 \vsp
729 volt&
730     electrical potential difference&
731     \si{V}&
732     \verb+\si{V}+&
733     \si{kg\m\squared\per\s\cubed\per\A}\
734 \quad picovolt&
735     \ditto&
736     \si{pV}&
737     \verb+\si{pV}+&
738     \SI{e-12}{\V}\
739 \quad nanovolt&
740     \ditto&
741     \si{nV}&
742     \verb+\si{nV}+&
743     \SI{e-9}{\V}\
744 \quad microvolt&
745     \ditto&
746     \si{uV}&
747     \verb+\si{uV}+&
748     \SI{e-6}{\V}\
749 \quad millivolt&
750     \ditto&
751     \si{mV}&
752     \verb+\si{mV}+&
753     \SI{e-3}{\V}\
754 \quad kilovolt&
755     \ditto&
756     \si{kV}&
757     \verb+\si{kV}+&
758     \SI{e3}{\V}\
759 \vsp
760 watt&
761     power&
762     \si{W}&
763     \verb+\si{W}+&
764     \si{kg\m\squared\per\s\cubed}\
765 \quad microwatt&
766     \ditto&
767     \si{uW}&
768     \verb+\si{uW}+&
769     \SI{e-6}{\W}\
770 \quad milliwatt&
771     \ditto&
772     \si{mW}&
773     \verb+\si{mW}+&
774     \SI{e-3}{\W}\
775 \quad kilowatt&

```



```

776     \ditto&
777     \si{\kW}&
778     \verb+\si{\kW}+&
779     \SI{e3}{\W}\
780     \quad megawatt&
781     \ditto&
782     \si{\MW}&
783     \verb+\si{\MW}+&
784     \SI{e6}{\W}\
785     \quad gigawatt&
786     \ditto&
787     \si{\GW}&
788     \verb+\si{\GW}+&
789     \SI{e9}{\W}\
790     \vsp
791     weber&
792     magnetic flux&
793     \si{\Wb}&
794     \verb+\si{\Wb}+&
795     \si{\kg\m\squared\per\s\squared\per\A}\
796     \vsp
797     yard&
798     length&
799     \si{\yd}&
800     \verb+\si{\yd}+&
801     \SI{.9144}{\m}\ % not an SI unit
802     \vsp
803     year&
804     time&
805     \si{\y}&
806     \verb+\si{\y}+&
807     \SI{\approx 365.25}{\d}\ % not an SI unit
808     \end{longtable}
809 }

```

O. RESOURCES

Books:

- *L^AT_EX Beginner's Guide*, second edition, [32].

From the IEEE Author Center [33]

- The IEEE Editorial Style Manual for Authors [34] contains a formal set of editorial guidelines.
- Editing Mathematics [35] illustrates how to do mathematics.
- The IEEE Reference Guide [36] outlines how to cite references.

Question and Answer site:

- T_EX – L^AT_EX Stack Exchange is a question and answer site for users of T_EX, L^AT_EX, and related typesetting systems [37].

```
1 \chapter{RESOURCES}
2
3 Books:
4 \begin{itemize}
5   \item
6     \citetitle{kottwitz2021}, second edition, \cite{kottwitz2021}.
7 \end{itemize}
8
9 \noindent
10 From the
11 IEEE Author Center
12 \cite{ieee-author-center}
13 \begin{itemize}
14   \item
15     The
16     IEEE Editorial Style Manual for Authors
17     \cite{ieee-editorial-style-manual-for-authors}
18     contains a formal set of editorial guidelines.
19   \item
20     Editing Mathematics
21     \cite{editing-mathematics}
22     illustrates how to do mathematics.
23   \item
24     The
25     IEEE Reference Guide
26     \cite{ieee-reference-guide}
27     outlines how to cite references.
28 \end{itemize}
29
30 \noindent
31 Question and Answer site:
32 \begin{itemize}
33   \item
34     \TeX\ -- \LaTeX\ Stack Exchange
35     is a question and answer site
36     for users of
37     \TeX,
38     \LaTeX,
39     and related typesetting systems
40     \cite{tex-stackexchange}.
41 \end{itemize}
```

P. TABLES

```
1 \chapter{TABLES}
2 \ix{table}
```

Here is a really simple table. I was greatly influenced by Herbert Voss' following ideas on typesetting tables [38]: Use `\toprule`, `\midrule`, and `\bottomrule`. Don't have blank horizontal space to the left or right of body of table.

Table P.1. The first three American Presidents.

Number	Name
1	George Washington
2	John Adams
3	Thomas Jefferson

```
1
2 Here is a really simple table.
3 I was greatly influenced
4 by Herbert Voss' following ideas
5 on typesetting tables
6 \cite{voss2011}:
7 Use \toprule, \midrule, and \bottomrule.
8 \index{\verb+\toprule+}
9 \index{\verb+\midrule+}
10 \index{\verb+\bottomrule+}
11 Don't have blank horizontal space to the left
12 or right of body of table.
13 \ix{Voss, Herbert}
14
15 % "h" means put table "here"---don't let it float to top or bottom of page
16 \begin{table}[ht]
17   \caption{The first three American Presidents.}
18   \vspace*{6pt}
19   \centering
20   % Table format:
21   %   WHAT   DESCRIPTION
22   %   @{}   don't put extra space before first column
23   %   r     right justify first column
24   %   l     left justify second column
25   %   @{}   don't put extra space after second column
26   \begin{tabular}{@{}rl@{}}
27     \toprule
28     \bf Number& \bf Name\\
29     \midrule
30     1& George Washington\\
31     2& John Adams\\
32     3& Thomas Jefferson\\
33     \bottomrule
34   \end{tabular}
35   \label{ta:first-three-american-presidents}
36 \end{table}
37 \ix{table}
38 \index{\verb+\begin{table}+}
```

Here is the same table with a longer caption.

Table P.2. The first three American Presidents. This caption is much, much, much, much, much, much, much, much, much, much longer.

Number	Name
1	George Washington
2	John Adams
3	Thomas Jefferson

```

1
2 \newpage
3
4 Here is the same table with a longer caption.
5
6 % "h" means put table "here"---don't let it float to top or bottom of page
7 \begin{table}[ht]
8   \caption{%
9     The first three American Presidents.
10    This caption is
11    much, much, much, much, much, much,
12    much, much, much, much, much, much
13    longer.%
14  }
15  \vspace*{6pt}
16  \centering
17  % Table format:
18  %   WHAT   DESCRIPTION
19  %   @{}    don't put extra space before first column
20  %   r      right justify first column
21  %   l      left justify second column
22  %   @{}    don't put extra space after second column
23  \begin{tabular}{@{}rl@{}}
24    \toprule
25    \bf Number& \bf Name\\
26    \midrule
27    1& George Washington\\
28    2& John Adams\\
29    3& Thomas Jefferson\\
30    \bottomrule
31  \end{tabular}
32  \label{ta:first-three-american-presidents-longer-caption}
33 \end{table}

```

\LaTeX can print horizontal and vertical rules in tables. I don't like the way this looks and suggest you do not use tables with lots of horizontal and vertical lines.

Table P.3. The first three American Presidents with horizontal and vertical lines

#	Name
1	George Washington
2	John Adams
3	Thomas Jefferson

```

1
2 \newpage
3
4 \LaTeX\ can print horizontal
5 and vertical rules in tables.
6 I don't like the way this looks
7 and suggest you do not use tables
8 with lots of horizontal and vertical lines.
9 \begin{table}[ht]
10 \caption{The first three American Presidents with horizontal and vertical lines}
11 \vspace*{6pt}
12 \centering
13 % Table format:
14 % WHAT DESCRIPTION
15 % @{} don't put any space left of first column
16 % | print a vertical rule
17 % c center column
18 % | print a vertical rule
19 % l left justify column
20 % | print a vertical rule
21 % @{} don't put any space right of last column
22 \begin{tabular}{@{}|c|l|@{}}
23 % "\hline" prints a horizontal rule
24 \hline
25 \bf \#\& \bf Name\\
26 \hline
27 1& George Washington\\
28 \hline
29 2& John Adams\\
30 \hline
31 3& Thomas Jefferson\\
32 \hline
33 \end{tabular}
34 \label{ta:American-Presidents-with-horizontal}
35 \end{table}

```

Here is a more complicated table.

Table P.4. C Bitwise Operators

A	B	A B	A&B
0	0	0	0
0	1	1	0
1	0	1	0
1	1	1	1

```

1
2 \newpage
3
4 Here is a more complicated table.
5
6 {
7   \UndefineShortVerb{\|}
8   \begin{table}[ht]
9     \caption{C Bitwise Operators}
10    \vspace*{6pt}
11    \centering
12    % Table format:
13    %   WHAT      DESCRIPTION
14    %   @{}      don't put extra space before first column
15    %   c         first column is centered
16    %   c         second column is centered
17    %   c         third column is centered
18    %   c         fourth column is centered
19    %   @{}      don't put extra space after fourth column
20    \begin{tabular}{@{}cccc@{}}
21      \toprule
22      \bf A& \bf B& \bf A\(|\)\B& \bf A&B\\[2pt]
23      \midrule
24      0& 0& 0& 0\\
25      0& 1& 1& 0\\
26      1& 0& 1& 0\\
27      1& 1& 1& 1\\
28      \bottomrule
29    \end{tabular}
30    \label{ta:C-Bitwise}
31  \end{table}
32 }

1 \begin{table}[ht]
2   \caption{Participant descriptors for twelve practitioners engaged in co-creation activities}
3   \label{tab:22participants}
4   \center
5   \begin{tabular}{@{}c|l|S@{}}
6     \toprule
7     \multicolumn{1}{@{}l}{\textbf{Pseudonym}}&
8     \textbf{Disciplinary Role}&
9     \textbf{Company Type}&
10    \multicolumn{1}{l@{}}{\textbf{\# Years of Experience}}\\
11    \midrule
12    \multicolumn{4}{@{}l@{}}%

```

Table P.5. Participant descriptors for twelve practitioners engaged in co-creation activities

Pseudonym	Disciplinary Role	Company Type	# Years of Experience
Sequence 1: A1.1 → B2.1: Overlapping dilemma cards to strengthen and represent ethical complexity through practitioner’s current ecological complexity model			
1P1	UX Designer	Enterprise (B2C)	1.5
1P2	Product Manager	Enterprise (B2B)	5
1P3	Data Scientist	Agency or Consultancy	1
Sequence 2: B2.1 → A1.1: Building and tracing complexity based on Dilemmas Cards to reconstruct and reflect on their experience			
2P1	UX Designer	Agency or Consultancy	8
2P2	Product Manager	Agency or Consultancy	2
2P3	Software Engineer	Enterprise (B2B)	2

```

13      {%
14      \textbf{Sequence 1:} $\text{A1.1}\to\text{B2.1}$:
15      Overlapping dilemma cards to strengthen and represent%
16      }\
17      \multicolumn{4}{@{}1}{ethical complexity
18      through practitioner’s current ecological complexity model}\
19      1P1& UX Designer& Enterprise (B2C)& 1.5\
20      1P2& Product Manager& Enterprise (B2B)& 5\
21      1P3& Data Scientist& Agency or Consultancy& 1\
22      \noalign{\vspace{8pt}}
23      \multicolumn{4}{@{}1@{}}%
24      {%
25      \textbf{Sequence 2:} $\text{B2.1}\to\text{A1.1}$:
26      Building and tracing complexity based on Dilemmas Cards%
27      }\
28      \multicolumn{4}{@{}1}{to reconstruct and reflect on their experience}\
29      2P1& UX Designer& Agency or Consultancy& 8\
30      2P2& Product Manager& Agency or Consultancy& 2\
31      2P3& Software Engineer& Enterprise (B2B)& 2\
32      \bottomrule
33      \end{tabular}
34      \end{table}

```

Here is a table that is too long to fit on one page.

Table P.6. State Abbreviations

State	Abbreviation
Alabama	AL
Alaska	AK
American Samoa	AS
Arizona	AZ
Arkansas	AR
Armed Forces Europe	AE
Armed Forces Pacific	AP
Armed Forces the Americas	AA
California	CA
Colorado	CO
Connecticut	CT
Delaware	DE
District of Columbia	DC
Federated States of Micronesia	FM
Florida	FL
Georgia	GA
Guam	GU
Hawaii	HI
Idaho	ID
Illinois	IL
Indiana	IN
Iowa	IA
Kansas	KS
Kentucky	KY
Louisiana	LA
Maine	ME
Marshall Islands	MH
Maryland	MD
Massachusetts	MA
Michigan	MI
Minnesota	MN
Mississippi	MS
Missouri	MO
Montana	MT
Nebraska	NE
Nevada	NV
New Hampshire	NH
New Jersey	NJ
New Mexico	NM

continued on next page

34 Connecticut& CT\\
35 Delaware& DE\\
36 District of Columbia& DC\\
37 Federated States of Micronesia& FM\\
38 Florida& FL\\
39 Georgia& GA\\
40 Guam& GU\\
41 Hawaii& HI\\
42 Idaho& ID\\
43 Illinois& IL\\
44 Indiana& IN\\
45 Iowa& IA\\
46 Kansas& KS\\
47 Kentucky& KY\\
48 Louisiana& LA\\
49 Maine& ME\\
50 Marshall Islands& MH\\
51 Maryland& MD\\
52 Massachusetts& MA\\
53 Michigan& MI\\
54 Minnesota& MN\\
55 Mississippi& MS\\
56 Missouri& MO\\
57 Montana& MT\\
58 Nebraska& NE\\
59 Nevada& NV\\
60 New Hampshire& NH\\
61 New Jersey& NJ\\
62 New Mexico& NM\\
63 New York& NY\\
64 North Carolina& NC\\
65 North Dakota& ND\\
66 Northern Mariana Islands& MP\\
67 Ohio& OH\\
68 Oklahoma& OK\\
69 Oregon& OR\\
70 Pennsylvania& PA\\
71 Puerto Rico& PR\\
72 Rhode Island& RI\\
73 South Carolina& SC\\
74 South Dakota& SD\\
75 Tennessee& TN\\
76 Texas& TX\\
77 Utah& UT\\
78 Vermont& VT\\
79 Virgin Islands& VI\\
80 Virginia& VA\\
81 Washington& WA\\
82 West Virginia& WV\\
83 Wisconsin& WI\\
84 Wyoming& WY\\
85 \multicolumn{2}{c}{make this three pages long}\\
86 \multicolumn{2}{c}{make this three pages long}\\
87 \multicolumn{2}{c}{make this three pages long}\\
88 \multicolumn{2}{c}{make this three pages long}\\
89 \multicolumn{2}{c}{make this three pages long}\\
90 \multicolumn{2}{c}{make this three pages long}\\
91 \multicolumn{2}{c}{make this three pages long}\\
92 \multicolumn{2}{c}{make this three pages long}\\
93 \multicolumn{2}{c}{make this three pages long}\\
94 \multicolumn{2}{c}{make this three pages long}\\
95 \multicolumn{2}{c}{make this three pages long}\\
96 \multicolumn{2}{c}{make this three pages long}\\
97 \multicolumn{2}{c}{make this three pages long}

```
98 \multicolumn{2}{c}{make this three pages long}\\
99 \multicolumn{2}{c}{make this three pages long}\\
100 \multicolumn{2}{c}{make this three pages long}\\
101 \multicolumn{2}{c}{make this three pages long}\\
102 \multicolumn{2}{c}{make this three pages long}\\
103 \multicolumn{2}{c}{make this three pages long}\\
104 \multicolumn{2}{c}{make this three pages long}\\
105 \multicolumn{2}{c}{make this three pages long}\\
106 \multicolumn{2}{c}{make this three pages long}\\
107 \multicolumn{2}{c}{make this three pages long}\\
108 \multicolumn{2}{c}{make this three pages long}\\
109 \multicolumn{2}{c}{make this three pages long}\\
110 \multicolumn{2}{c}{make this three pages long}\\
111 \multicolumn{2}{c}{make this three pages long}\\
112 \multicolumn{2}{c}{make this three pages long}\\
113 \multicolumn{2}{c}{make this three pages long}\\
114 \multicolumn{2}{c}{make this three pages long}\\
115 \multicolumn{2}{c}{make this three pages long}\\
116 \multicolumn{2}{c}{make this three pages long}\\
117 \multicolumn{2}{c}{make this three pages long}\\
118 \multicolumn{2}{c}{make this three pages long}\\
119 \multicolumn{2}{c}{make this three pages long}\\
120 \end{longtable}
```

```

1
2 % The table is on the next page.
3
4 \newpage
5
6 % Set \LTcapwidth (the longtable caption width)
7 % to \textwidth minus 4 paragraph indent widths.
8 \setlength{\LTcapwidth}{\textwidth}
9 \addtolength{\LTcapwidth}{-4\parindent}
10
11 \newlength{\twidth}
12 \newlength{\theight}
13
14 \setlength{\twidth}{\textwidth}
15 \setlength{\theight}{\textheight}
16
17 \begin{sidewaystable}
18 % The following two lines compensate for what I think is a bug.
19 \setlength{\textwidth}{\theight}
20 \setlength{\textheight}{\twidth}
21 \caption{Sidewaystable of the first three American Presidents.}
22 \vspace*{6pt}
23 \centering
24 \begin{tabular}{@{}rl@{}}
25 \toprule
26 \bf Number& \bf Name\\
27 \midrule
28 1& George Washington\\
29 2& John Adams\\
30 3& Thomas Jefferson\\
31 \bottomrule
32 \end{tabular}
33 \end{sidewaystable}

```

Table P.7. Sidewaystable of the first three American Presidents.

Number	Name
1	George Washington
2	John Adams
3	Thomas Jefferson

```

1 \begin{sidewaystable}
2   % The following two lines compensate for what I think is a bug.
3   \setlength{\textwidth}{\theight}
4   \setlength{\textheight}{\twidth}
5   \caption{Two tables can be placed vertically in a sideways table environment.}
6   \vspace*{6pt}
7   \centering
8   \begin{tabular}{@{}rl@{}}
9     \toprule
10    \bf Number& \bf Name\\
11    \midrule
12    1& George Washington\\
13    2& John Adams\\
14    3& Thomas Jefferson\\
15    \bottomrule
16  \end{tabular}
17  \vspace*{2\baselineskip}
18  \caption{This is the second table in the sideways environment.}
19  \vspace*{6pt}
20  \begin{tabular}{@{}rl@{}}
21    \toprule
22    \bf Number& \bf Name\\
23    \midrule
24    1& George Washington\\
25    2& John Adams\\
26    3& Thomas Jefferson\\
27    \bottomrule
28  \end{tabular}
29 \end{sidewaystable}

```

Table P.8. Two tables can be placed vertically in a sidewaysstable environment.

Number	Name
1	George Washington
2	John Adams
3	Thomas Jefferson

Table P.9. This is the second table in the sideways environment.

Number	Name
1	George Washington
2	John Adams
3	Thomas Jefferson

```

1 \begin{sidewaystable}[ht]%
2 % The following two lines compensate for what I think is a bug.
3 \setlength{\textwidth}{\theight}%
4 \setlength{\textheight}{\twidth}%
5 \caption{Live Guitar Open String Testing Data - Pitch (\textit{f\textsubscript{0}})}
6 \vspace*{6pt}%
7 \label{ta:live-guitar}%
8 % Define "Live Guitar Test" column.
9 \def\lgt#1{\bf Live Guitar Test #1}
10 % Define "Note", "Computed", "Measured", "%", and "Accuracy" column headings.
11 \def\note{\bf Note}
12 \def\cal{\bf Computed}
13 \def\mea{\bf Measured}
14 \def\per{\bf \%}
15 \def\acc{\bf Accuracy}
16 % Define "Name", "f_0 (Hz)", "Error", and "Range (\textcent)" column headings.
17 \def\name{\bf Name}
18 \def\fsz{\bf \textit{f\textsubscript{0}} (Hz)}
19 \def\err{\bf Error}
20 \def\ran{\bf Range (\textcent)}
21 % Make "!" be an invisible character the width of a digit.
22 % (All digits in the normal font are the same width.)
23 \catcode'\!=\active \def!\{\hphantom 1}
24 \hbox to \textwidth
25 {%
26 \hss
27 % From http://zerocapcable.com/?page_id=225
28 % The units of tuning accuracy are cents. A cent is one hundredth
29 % of a semitone. Since there are 12 semitones in an octave, there
30 % are 1200 cents in an octave.
31 % The default \tabcolsep is 6.0pt.
32 \setlength{\tabcolsep}{5pt}%
33 \begin{tabular}{@{}cc|ccc|ccc|ccc@{}}
34 \hline
35 \multicolumn{2}{c|}{ }&
36 \multicolumn{3}{c|}{\lgt1}&
37 \multicolumn{3}{c|}{\lgt2}&
38 \multicolumn{3}{c|}{\lgt3}\
39 \cline{3-11}
40 \note& \cal& \mea& \per& \acc& \mea& \per& \acc& \mea& \per& \acc\
41 \name& \fsz& \fsz& \err& \ran& \fsz& \err& \ran& \fsz& \err& \ran\
42 \hline
43 E\textsubscript 2& !82.407& !82.333& 0.0897& $+2$& !82.616& 0.2538& $+6$& !82.474& 0.0814& $+2$\\
44 A\textsubscript 2& 110.000& 110.092& 0.0836& $+2$& 110.092& 0.0836& $+2$& 110.092& 0.0836& $+2$\\
45 D\textsubscript 3& 146.832& 146.789& 0.0295& $-2$& 146.789& 0.0295& $-2$& 147.239& 0.2769& $+6$\\
46 G\textsubscript 3& 195.998& 196.721& 0.3690& $+8$& 195.918& 0.0407& $+2$& 196.721& 0.3690& $+8$\\
47 B\textsubscript 3& 246.942& 247.423& 0.1949& $+4$& 246.517& 0.1720& $-4$& 247.423& 0.1949& $+4$\\
48 E\textsubscript 4& 329.628& 331.034& 0.4267& $+8$& 331.034& 0.4267& $+8$& 331.034& 0.4267& $+8$\\
49 \hline
50 \multicolumn{11}{@{}l}{Thanks to Kathryn Schmidt for donating this table.}\
51 \end{tabular}
52 \hss
53 }
54 \end{sidewaystable}

```

Table P.10. Live Guitar Open String Testing Data - Pitch (f_0)

Note Name	Computed f_0 (Hz)	Live Guitar Test 1			Live Guitar Test 2			Live Guitar Test 3		
		Measured f_0 (Hz)	% Error	Accuracy Range (c)	Measured f_0 (Hz)	% Error	Accuracy Range (c)	Measured f_0 (Hz)	% Error	Accuracy Range (c)
E ₂	82.407	82.333	0.0897	+2	82.616	0.2538	+6	82.474	0.0814	+2
A ₂	110.000	110.092	0.0836	+2	110.092	0.0836	+2	110.092	0.0836	+2
D ₃	146.832	146.789	0.0295	-2	146.789	0.0295	-2	147.239	0.2769	+6
G ₃	195.998	196.721	0.3690	+8	195.918	0.0407	+2	196.721	0.3690	+8
B ₃	246.942	247.423	0.1949	+4	246.517	0.1720	-4	247.423	0.1949	+4
E ₄	329.628	331.034	0.4267	+8	331.034	0.4267	+8	331.034	0.4267	+8

Thanks to Kathryn Schmidt for donating this table.

```

1 % Define a control sequence to save typing.
2 % Let * represent zero or more spaces!
3 % Method 1: \def\g#1{ requires using \g*{10} for 10.
4 %           Two shifted characters, { and } are needed.
5 % Method 2: \def\g#1/{ requires using \g*10/ for 10.
6 %           One unshifted character, / is needed.
7 % Method 2 requires less work than Method 1.
8 \def\g#1/{\includegraphics[scale=0.5]{gr-metapost-tally-#1.pdf}}%
9
10 % Define a length for use later.
11 \newlength{\tlen}
12 \setlength{\tlen}{2\parindent}

```

Table P.11. First tally table. Use this method. I think it is the simplest.

```

1 \begin{table}[h]%
2 \label{ta:first-tally-table}
3 \caption
4 [%
5 First tally table. Use this method.%
6 ]%
7 {%
8 First tally table. Use this method. I think it is the simplest.
9 }
10 \vspace*{6pt}
11 % Note that tabular* instead of tabular is used below.
12 % The {\textwidth} makes the total width of the table the width
13 % of the printed area of the page.
14 % The @{\kern\tlen} puts blank space the width of two paragraph indents
15 % before the first column.
16 % The @{\extracolsep{\fill}} adds \fill space between all subsequent
17 % columns.
18 % The lll left justifies the next three columns.
19 % after the column.
20 % The @{\kern\tlen} puts blank space the width of two
21 % paragraph indents before the first column.
22 \begin{tabular*}{\textwidth}{@{\kern\tlen}@{\extracolsep{\fill}}lll@{\kern\tlen}}%
23 \g 01/& \g 02/& \g 03/\
24 \g 04/& \g 05/\
25 \end{tabular*}%
26 \end{table}

```

Table P.12. Second tally table. Don't use this method. The method used in the first tally table is easier to understand.

```

1 \begin{table}[h]
2 \caption{
3   Second tally table.
4   Don't use this method.
5   The method used in the first tally table
6   is easier to understand.%
7 }%
8 \vspace*{6pt}
9 % Note that tabularx instead of tabular is used below.
10 % The {\textwidth} makes the total width of the table the width
11 % of the printed area on the page.
12 % The @{\kern\tlen} puts blank space the width of two paragraph indents
13 % before the first column.
14 % The XX makes the first two columns the same width including the space
15 % after the column.
16 % The l left justifies the last column.
17 % The @{\kern\tlen} puts blank space the width of two paragraph indents
18 % after the last column.
19 \begin{tabularx}{\textwidth}{@{\kern\tlen}XXl@{\kern\tlen}}%
20   \g 01/& \g 02/& \g 03/\
21   \g 04/& \g 05/\
22 \end{tabularx}%
23 \end{table}

```

Table P.13. Third tally table. Don't use this method. The method used in the first tally table is easier to understand.

```

1 \begin{table}[h!]
2 \caption{
3   Third tally table.
4   Don't use this method.
5   The method used in the first tally table
6   is easier to understand.%
7 }%
8 \vspace*{6pt}
9 \def\t #1/#2/#3/%
10 {%
11   \hbox to\textwidth{%
12     \kern\tlen \g #1/\hfil \g #2/\hfil \g #3/\kern\tlen
13   }%
14 }%
15 \vbox{
16   \t 01/02/03/
17   \hbox to\textwidth{%
18     \kern\tlen \g 04/\hfil \g 05/\hfil \phantom{\g 05/}\kern\tlen
19   }%
20 }
21 \end{table}

```

```

1
2
3 % Process all unprocessed floats.
4 % None of the current floats will be after the \FloatBarrier.
5 \FloatBarrier

```

Q. SPECIAL CHARACTERS

```

1 \chapter{SPECIAL CHARACTERS}
2 \ix{special characters//Special Characters appendix}

```

Symbol	L ^A T _E X Input	Comment
¡	<code>\textexclamdown</code>	inverted exclamation mark ! ' also works in PurdueThesis
¿	<code>\textquestiondown</code>	inverted question mark ? ' also works in PurdueThesis
ő	<code>\H{o}</code>	Hungarian o with double acute

```

1 % The following two lines compensate for what I think is a bug.
2 \begin{tabular}{@{}l|l|l@{}}
3 \toprule
4 \textbf{Symbol} & \textbf{\LaTeX\ Input}& \textbf{Comment}\\
5 \midrule
6 \textexclamdown & |\textexclamdown| & inverted exclamation mark\\
7 & & & |!'| also works in PurdueThesis\\
8 \textquestiondown& |\textquestiondown| & inverted question mark\\
9 & & & |?'| also works in PurdueThesis\\
10 \H{o} & & |\H{o}| & Hungarian o with double acute\\
11 \bottomrule
12 \end{tabular}
13 \index{special characters}
14 \index{\verb+\begin{tabular}+}

```

R. TESTING (THIS APPENDIX IS USED FOR TESTING, DOES THIS VERY, VERY, VERY, VERY, VERY, VERY, VERY, VERY, VERY, VERY, VERY, VERY, VERY, VERY, LONG TITLE LOOK OK?)

METAPOST

Input	Output	Comment
PurdueThesis	PurdueThesis	just ordinary text
\PurdueThesisLogo	PurdueThesis	PurdueThesis logo, less space between P and u, e and T, and T and h
\PuThLogo	PuTh	PuTh abbreviation logo

R.1 Figure Captions

This is a paragraph.

```
1
2 \paragraph{This is a paragraph.}
```

This is the figure.

Figure R.1. This is the caption. This is the caption. This is the caption.
This is the caption. This is the caption. This is the caption.

```
1
2 \begin{figure}[h]
3   This is the figure.
4   \caption
5   [%
6     This is the caption. This is the caption. This is the caption.
7     This is the caption. This is the caption. This is the caption.%
8   ]%
9   {%
10    This is the caption. This is the caption. This is the caption.
11    This is the caption. This is the caption. This is the caption.%
12  }
13 \end{figure}
```

R.2 Apostrophes

Test apostrophes in text mode: f', f'', and f'''.

Test apostrophes in math mode: f' , f'' , and f''' .

```
1
2
3 \section{Apostrophes}
```

```

4
5 Test apostrophes in text mode: f', f'', and f''' .
6
7 Test apostrophes in math mode: \(\f',\ f'',\text{ and }f'''\).

```

R.3 Citations

Do a bunch of citations:

```

[39]–[48]
[49]–[58]
[59]–[68]
[69]–[78]
[79]–[88]
[89]–[98]
[99]–[108]
[109]–[118]
[119]–[128]
[129]–[138].

```

If numeric citations are used, these numeric citations get “compressed”:

```

[39], [41], [42], [44], [46], [47], [130], [137], [138].

```

```

1
2
3 \section{Citations}
4
5 Do a bunch of citations:\\
6 \cite{t001,t002,t003,t004,t005,t006,t007,t008,t009,t010}\\
7 \cite{t011,t012,t013,t014,t015,t016,t017,t018,t019,t020}\\
8 \cite{t021,t022,t023,t024,t025,t026,t027,t028,t029,t030}\\
9 \cite{t031,t032,t033,t034,t035,t036,t037,t038,t039,t040}\\
10 \cite{t041,t042,t043,t044,t045,t046,t047,t048,t049,t050}\\
11 \cite{t051,t052,t053,t054,t055,t056,t057,t058,t059,t060}\\
12 \cite{t061,t062,t063,t064,t065,t066,t067,t068,t069,t070}\\
13 \cite{t071,t072,t073,t074,t075,t076,t077,t078,t079,t080}\\
14 \cite{t081,t082,t083,t084,t085,t086,t087,t088,t089,t090}\\
15 \cite{t091,t092,t093,t094,t095,t096,t097,t098,t099,t100}.
16
17 If numeric citations are used,
18 these numeric citations get ‘‘compressed’’:\\
19 \cite{t100,t099,t001,t002,t003,t005,,t007,t008,t098}\\.

```

R.4 Footnote

This is a footnote¹

```

1
2
3 \section{Footnote}
4

```

¹↑This is a footnote.

```

5 This is a footnote\footnote{This is a footnote.}%
6 \index{\verb+\footnote+}%
7 \ix{footnote}

```

R.5 Section heading in SmallCaps font

Section headings with `{\protect\scshape SmallCaps}` don't work.

This does not work:

```
\section{Section heading in {\protect\scshape SmallCaps} font}
```

use

```

\section
  [Section heading with {\protect\scshape SmallCaps}]%
  {Section heading with S{\protect\scriptsize MALL}C{\protect\scriptsize APS}}

```

instead.

R.6 To-do notes

Make a todo comment.

The Purdue football game is at noon tomorrow.

$$\sum_1^n = 1, 2, \dots, n - 1$$

```

1
2
3 \section{To-do notes}
4
5 Make a todo comment.%
6 \todocomment{Some people use "to-do",
7   but I want to be consistent with command names.}
8
9 The Purdue football game is at noon tomorrow.%
10 \todowarn{Leave at 10:00---the traffic will be terrible.}
11
12 \[
13   \sum_1^n = 1, 2, \ldots, n - 1
14 \]%
15 \todoerror{\(n-1\) should be \(\n\)}.}

```

Cite a reference with a very, very, very, ... long title [139].

```

1 Cite a reference with a very, very, very, \ldots long title
2 \cite{test-long-title}.

```

@mischambleton, key = Deep Space Gateway, title = Deep Space Gateway to Open Opportunities for Distant Destinations, note = Editor: Kathryn Hambleton, year = 2018, month = August 24., howpublished = <https://www.nasa.gov/feature/deep-space-gateway-to-open-opportunities>, organization = NASA

Emily Spreen wrote that the following URLs are invisible in the PDF file.

```
@misc{gerstenmaier,
  author = {William H. Gerstenmaier},
  title = {{Progress in Defining the Deep Space Gateway and Transport Plan}},
  month = {March},
  year = {2017},
  howpublished = {\url{https://www.nasa.gov/sites/default/files/atoms/files/nss_chart_v23.pdf}},
  organization = {NASA}
}
```

I suggest using the following (added a ‘2’ to the key so they’d have separate entries in the references.).

```
@misc{gerstenmaier2,
  author = {William H. Gerstenmaier},
  title = {{Progress in Defining the Deep Space Gateway and Transport Plan}},
  date = {2017-03},
  url = {https://www.nasa.gov/sites/default/files/atoms/files/nss_chart_v23.pdf},
  organization = {NASA}
}
```

See [23] and [24] in the REFERENCES.

```
1 Emily Spreen wrote that the following URLs are invisible in the PDF file.
2
3 \begin{verbatim}
4 @misc{gerstenmaier,
5   author = {William H. Gerstenmaier},
6   title = {{Progress in Defining the Deep Space Gateway and Transport Plan}},
7   month = {March},
8   year = {2017},
9   howpublished = {\url{https://www.nasa.gov/sites/default/files/atoms/files/nss_chart_v23.pdf}},
10  organization = {NASA}
11 }
12 \end{verbatim}
13
14 I suggest using the following
15 (added a ‘2’ to the key so they’d have separate entries in the references.).
16 \begin{verbatim}
17 @misc{gerstenmaier2,
18   author = {William H. Gerstenmaier},
19   title = {{Progress in Defining the Deep Space Gateway and Transport Plan}},
20   date = {2017-03},
21   url = {https://www.nasa.gov/sites/default/files/atoms/files/nss_chart_v23.pdf},
22   organization = {NASA}
23 }
24 \end{verbatim}
25
26 See \cite{gerstenmaier} and \cite{gerstenmaier2} in the REFERENCES.
```

S. TEXT

```
1 \chapter{TEXT}
2
3 \ix{Text}
```

S.1 Color

The soul package [140] package is loaded by `thesis.tex`. The package defines the following commands: `this text is highlighted in yellow and is so long it is absolutely guaranteed to go to the next line` for testing. See the citation for much more information.

The xcolor package [141] package is loaded by `PurdueThesis`. The package defines the following commands: `this text is printed in red and is so long it is absolutely guaranteed to go to the next line` for testing. See the citation for much more information.

```
1
2
3 \section{Color}
4
5 The soul package \cite{franz2003} package is loaded by |thesis.tex|.
6 The package defines the following commands:
7 \hl{%
8   this text is highlighted in yellow
9   and is so long it is absolutely guaranteed
10  to go to the next line%
11 } for testing.
12 See the citation for much more information.
13
14 The xcolor package \cite{kern2021} package is loaded by \PurdueThesisLogo.
15 The package defines the following commands:
16 \textcolor{red}{%
17   this text is printed in red
18   and is so long it is absolutely guaranteed
19   to go to the next line%
20 } for testing.
21 See the citation for much more information.
```

S.2 Description, enumerate, and itemize environments

The first example:

elephant This is the elephant item of a description environment. This is the elephant item of a description environment. This is the elephant item of a description environment.

frog This is the frog item of a description environment. This is the frog item of a description environment. This is the frog item of a description environment.

1. This is the first item of an enumerate environment. This is the first item of an enumerate environment. This is the first item of an enumerate environment.
2. This is the second item of an enumerate environment. This is the second item of an enumerate environment. This is the second item of an enumerate environment.

- This is the first item of an itemize environment. This is the first item of an itemize environment. This is the first item of an itemize environment.
- This is the second item of an itemize environment. This is the second item of an itemize environment. This is the second item of an itemize environment.

```

1
2 % The \sentence command is also defined in the convington package
3 % so I'll comment this one out. I don't think this sentence
4 % command is used.
5 % \newcommand\sentence[1]{\MyRepeat{This is a sentence. }{#1}}
6
7 \section{Description, enumerate, and itemize environments}
8 \ix{description environment//enumerate environment//itemize environment}
9 \index{\verb+\begin{description}+}
10 \index{\verb+\begin{enumerate}+}
11 \index{\verb+\begin{itemize}+}
12
13 The first example:
14
15 \begin{description}
16   \item[elephant]
17     \MyRepeat{This is the elephant item of a description environment. }{3}
18   \item[frog]
19     \MyRepeat{This is the frog item of a description environment. }{3}
20 \end{description}
21
22 \begin{enumerate}
23   \item
24     \MyRepeat{This is the first item of an enumerate environment. }{3}
25   \item
26     \MyRepeat{This is the second item of an enumerate environment. }{3}
27 \end{enumerate}
28
29 \begin{itemize}
30   \item
31     \MyRepeat{This is the first item of an itemize environment. }{3}
32   \item
33     \MyRepeat{This is the second item of an itemize environment. }{3}
34 \end{itemize}

```

The second example:

elephant This is the elephant item of a level zero description environment. This is the elephant item of a level zero description environment.

1. This is the first item of a level one enumerate environment. This is the first item of a level one enumerate environment.
 - This is the first item of a level two itemize environment. This is the first item of a level two itemize environment.
 - This is the first item of a level two itemize environment. This is the first item of a level two itemize environment.
2. This is the second item of a level one enumerate environment. This is the second item of a level one enumerate environment.

frog This is the frog item of a level zero description environment. This is the frog item of a level zero description environment.

```
1 The second example:
2
3 \begin{description}
4   \item[elephant]
5     \MyRepeat{This is the elephant item of a level zero description environment. }{2}
6   \begin{enumerate}
7     \item
8       \MyRepeat{This is the first item of a level one enumerate environment. }{2}
9     \begin{itemize}
10      \item
11        \MyRepeat{This is the first item of a level two itemize environment. }{2}
12      \item
13        \MyRepeat{This is the first item of a level two itemize environment. }{2}
14      \end{itemize}
15    \item
16      \MyRepeat{This is the second item of a level one enumerate environment. }{2}
17    \end{enumerate}
18   \item[frog]
19     \MyRepeat{This is the frog item of a level zero description environment. }{2}
20 \end{description}
```

S.3 Computer program listings

```
1
2
3 \section{Computer program listings}
4
5 \lstset{language=Pascal}
6
7 \begin{ZZlisting}
8   \caption{This is the caption.}
9   \begin{CenteredBox}
10    This is the listing.
11   \end{CenteredBox}
12 \end{ZZlisting}
```

Listing S.1. This is the caption.
This is the listing.

Listing S.2. A Pascal Program

```
for i:=maxint to 0 do
begin
  { do nothing }
end;
Write( 'Case□insensitive.' );
Write( 'Pascal□keywords.' );
```

```

13
14 \begin{ZZlisting}
15   \caption{A Pascal Program}
16   \begin{CenteredBox}
17     \begin{lstlisting}
18     for i:=maxint to 0 do
19     begin
20       { do nothing }
21     end;
22     Write('Case insensitive. ');
23     WriteE('Pascal keywords. ');
24     \end{lstlisting}
25   \end{CenteredBox}
26 \end{ZZlisting}

```

S.4 Frenchspacing

The `\frenchspacing` command puts approximately $\frac{\text{one}}{\text{two}}$ spaces after sentences. The default is `\nonfrenchspacing`.

Lorem ipsum dolor sit amet, consectetur adipiscing elit. Nam cursus. Morbi ut mi. Nullam enim leo, egestas id, condimentum at, laoreet mattis, massa. Sed eleifend nonummy diam. Praesent mauris ante, elementum et, bibendum at, posuere sit amet, nibh. Duis tincidunt lectus quis dui viverra vestibulum. Suspendisse vulputate aliquam dui. Nulla elementum dui ut augue. Aliquam vehicula mi at mauris. Maecenas placerat, nisl at consequat rhoncus, sem nunc gravida justo, quis eleifend arcu velit quis lacus. Morbi magna magna, tincidunt a, mattis non, imperdiet vitae, tellus. Sed odio est, auctor ac, sollicitudin in, consequat vitae, orci. Fusce id felis. Vivamus sollicitudin metus eget eros.

Lorem ipsum dolor sit amet, consectetur adipiscing elit. Nam cursus. Morbi ut mi. Nullam enim leo, egestas id, condimentum at, laoreet mattis, massa. Sed eleifend nonummy diam. Praesent mauris ante, elementum et, bibendum at, posuere sit amet, nibh. Duis tincidunt lectus quis dui viverra vestibulum. Suspendisse vulputate aliquam dui. Nulla elementum dui ut augue. Aliquam vehicula mi at mauris. Maecenas placerat, nisl at consequat rhoncus, sem nunc gravida justo, quis eleifend arcu velit quis lacus. Morbi magna magna, tincidunt a, mattis non, imperdiet vitae, tellus. Sed odio est, auctor ac, sollicitudin in, consequat vitae, orci. Fusce id felis. Vivamus sollicitudin metus eget eros.

```

1
2
3 \section{Frenchspacing}%
4 \ix{frenchspacing//nonfrenchspacing}
5 \index{\verb+\frenchspacing+}
6 \index{\verb+\nonfrenchspacing+}
7
8 The
9 \def\t{\tt\char'134 frenchspacing}
10 \def\u{\tt\char'134 nonfrenchspacing}
11 \raise6pt\hbox{\rlap{\t}}%
12 \lower6pt\hbox{\u}
13 command puts approximately
14 \raise6pt\hbox{\rlap{one}}%
15 \lower6pt\hbox{two}
16 spaces after sentences.
17 The\[\!3pt]

```

```

18 default is |\nonfrenchspacing|.
19
20 {\frenchspacing
21 Lorem ipsum dolor sit amet, consectetur adipiscing elit. Nam
22 cursus. Morbi ut mi. Nullam enim leo, egestas id, condimentum at,
23 laoreet mattis, massa. Sed eleifend nonummy diam. Praesent mauris
24 ante, elementum et, bibendum at, posuere sit amet, nibh. Duis
25 tincidunt lectus quis dui viverra vestibulum. Suspendisse
26 vulputate aliquam dui. Nulla elementum dui ut augue. Aliquam
27 vehicula mi at mauris. Maecenas placerat, nisl at consequat
28 rhoncus, sem nunc gravida justo, quis eleifend arcu velit quis
29 lacus. Morbi magna magna, tincidunt a, mattis non, imperdiet
30 vitae, tellus. Sed odio est, auctor ac, sollicitudin in,
31 consequat vitae, orci. Fusce id felis. Vivamus sollicitudin metus
32 eget eros.\endgraf
33 }
34
35 Lorem ipsum dolor sit amet, consectetur adipiscing elit. Nam
36 cursus. Morbi ut mi. Nullam enim leo, egestas id, condimentum at,
37 laoreet mattis, massa. Sed eleifend nonummy diam. Praesent mauris
38 ante, elementum et, bibendum at, posuere sit amet, nibh. Duis
39 tincidunt lectus quis dui viverra vestibulum. Suspendisse
40 vulputate aliquam dui. Nulla elementum dui ut augue. Aliquam
41 vehicula mi at mauris. Maecenas placerat, nisl at consequat
42 rhoncus, sem nunc gravida justo, quis eleifend arcu velit quis
43 lacus. Morbi magna magna, tincidunt a, mattis non, imperdiet
44 vitae, tellus. Sed odio est, auctor ac, sollicitudin in,
45 consequat vitae, orci. Fusce id felis. Vivamus sollicitudin metus
46 eget eros.

```

S.5 Multiple Columns

Depending on what version of L^AT_EX you're running the `multicols` package may or may not do what you want.

This is one columnThis is one column. This is one column. This is one column. This is one column. This is one column. This is one column. This is one column. This is one column. This is one column. This is one column.

This is two columns. This is two columns.		This is two columns. This is two columns.
This is two columns. This is two columns.		This is two columns. This is two columns.
This is two columns. This is two columns.		This is two columns. This is two columns.

This is three columns.		three columns.	This is		three columns.	This is
This is three columns. This		three columns.	This is		three columns.	This is three
is three columns. This is		three columns.	This is		columns.	

This is four		columns. This is four		columns. This is four		columns. This is four
columns. This is four		columns. This is four		columns. This is four		columns.
columns. This is four		columns. This is four		columns. This is four		columns.

This is five		This is five		This is five		This is five		This is five
columns. This is		columns. This is		columns. This is		columns. This is		columns. This is
five columns.		five columns.		five columns.		five columns.		five columns.

```

1  \section{Multiple Columns}
2
3  Depending on what version of \LaTeX\ you're running
4  the \verb+multicols+ package may or may not do what
5  you want.
6
7  % The multicols package must be loaded for this to work.
8  % To load the multicols package put
9  %   \usepackage{multicols}
10 % between the "\documentclass" and "\begin{document}" commands.
11
12 % Put this amount of space between the columns.
13 % Let's use the default column separation to see what happens.
14 % \setlength{\columnsep}{0.5truein}
15
16 % Separate the columns with a vertical rule this wide.
17 % Make the column three times the default width.
18 \setlength{\columnseprule}{1.2pt}
19
20 This is one column\MyRepeat{This is one column. }{10}
21
22 \begin{multicols}{2}
23   \MyRepeat{This is two columns. }{12}
24 \end{multicols}
25
26 \begin{multicols}{3}
27   \MyRepeat{This is three columns. }{9}
28 \end{multicols}
29
30 \begin{multicols}{4}
31   \MyRepeat{This is four columns. }{10}
32 \end{multicols}
33
34 \begin{multicols}{5}
35   \MyRepeat{This is five columns. }{10}
36 \end{multicols}

```

S.6 Words

irregardless is a nonstandard word that means regardless. Use *regardless* instead [142].

out of date / out-of-date means “outmoded, obsolete”. [143].

When it comes after the noun, the compound adjective usually doesn’t get a hyphen. So we say an easy-to-remember number, but the number is easy to remember. Same goes for up to date—if it’s before a noun it needs a hyphen. A document is up to date but it’s an up-to-date document [144]. Also see [145].

In the context of writing about out-of-date software you may want to use “deprecated” [146] instead.

start-up / start-up company means a fledgling business enterprise [147]. I would use the more modern *startup* and only use *company* if not clear from the context.

peace out means “goodbye” [148]

```

1
2

```

```

3 \section{Words}
4
5 \newenvironment{entry}
6 {%
7   \bigskip
8   % Start a \vbox here.
9   % Everything in a \vbox is guaranteed to be on the same page.
10  \vbox\bgroup
11    \noindent
12  }
13 {%
14   % End the \vbox here.
15   \egroup
16 }
17
18 \begin{entry}
19   {\bfseries irregardless}\quad
20   is a nonstandard word that means regardless.
21   Use \emph{regardless} instead
22   \cite{merriam-webster-irregardless}.
23 \end{entry}
24
25 \begin{entry}
26   {\bfseries out of date / out-of-date}\quad
27   means ‘‘outmoded, obsolete’’.
28   \cite{merriam-webster-out-of-date}.
29
30   When it comes after the noun,
31   the compound adjective usually doesn’t get a hyphen.
32   So we say an easy-to-remember number,
33   but the number is easy to remember.
34   Same goes for up to date---if it’s before a noun it needs a hyphen.
35   A document is up to date but it’s an up-to-date document
36   \cite{thewriter-to-hyphenate-or-not-to-hyphenate}.
37   Also see
38   \cite{oed-out-of-date}.
39
40   In the context of writing about out-of-date software you may want to
41   use ‘‘deprecated’’ \cite{merriam-webster-deprecated} instead.
42 \end{entry}
43
44 \begin{entry}
45   {\bfseries start-up / start-up company}\quad
46   means a fledgling business enterprise
47   \cite{wikipedia-startup-company}.
48   I would use the more modern \emph{startup}
49   and only use \emph{company} if not clear from the context.
50 \end{entry}
51
52 \begin{entry}
53   {\bfseries peace out}\quad
54   means
55   ‘‘goodbye’’
56   \cite{online-slang-dictionary-peace-out}
57 \end{entry}

```

T. ASTRONOMY

```
1 \chapter{ASTRONOMY}
2 \ix{astronomy//Astronomy appendix}
3
4 \ix{astronomy}
5
```

U. BIOLOGY

- 1 \chapter{BIOLOGY}
- 2
- 3 \ix{Biology appendix}

V. CHEMISTRY

```
1 \chapter{CHEMISTRY}
2 \label{ch:chemistry}
3
4 \ix{chemistry}
5 \ix{Chemistry appendix}
6
```

V.1 Chemical Diagrams

The chemplants package [149] extends the [TikZ](#) package to draw chemical process units.

```
1
2
3 \section{Chemical Diagrams}
4
5 The chemplants package
6 \cite{feffin2019}
7 extends the
8 \href{http://ctan.math.washington.edu/tex-archive/graphics/pgf/base/doc/pgfmanual.pdf}{\TikZLogo}
9 package
10 to draw chemical process units.
```

V.2 Chemical Equations

The mhchem Bundle [150] contains mhchem v4.08 (chemical equations), hpstatement v1.02 (official hazard and precautionary statements), and rsphrase v3.11 (official risk and safety phrases).

```
1
2
3 \section{Chemical Equations}
4
5 The mhchem Bundle
6 \cite{hensel2018}
7 contains mhchem v4.08 (chemical equations),
8 hpstatement v1.02 (official hazard and precautionary statements),
9 and rsphrase v3.11 (official risk and safety phrases).
```

Defined in thesis.tex: NO₃⁻.

```
1
2 Defined in thesis.tex: \nitrate.
```

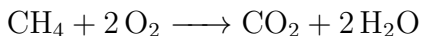

```
1
2 % See page 1 of
3 % https://www.thoughtco.com/what-is-a-chemical-equation-604026
4 \ce{CH4 + 2O2 -> CO2 + 2H2O}
```

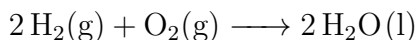

```

1
2 % See page 1 of
3 % https://www.thoughtco.com/what-is-a-chemical-equation-604026
4 \ce{2H2(g) + O2(g) -> 2H2O(l)}

```

$\text{Ag}^+(\text{aq}) + \text{NO}_3^-(\text{aq}) + \text{Na}^+(\text{aq}) + \text{Cl}^-(\text{aq}) \longrightarrow \text{AgCl}(\text{s}) + \text{Na}^+(\text{aq}) + \text{NO}_3^-(\text{aq})$ is an ionic equation of the chemical reaction: $\text{AgNO}_3(\text{aq}) + \text{NaCl}(\text{aq}) \longrightarrow \text{AgCl}(\text{s}) + \text{NaNO}_3(\text{aq})$

```

1
2 % See page 1 of
3 % https://www.thoughtco.com/definition-of-ionic-equation-605262
4 \ce{Ag+(aq) + NO3-(aq) + Na+(aq) + Cl-(aq) -> AgCl(s) + Na+(aq) + NO3-(aq)}
5 is an ionic equation of the chemical reaction:
6 \ce{AgNO3(aq) + NaCl(aq) -> AgCl(s) + NaNO3(aq)}

```

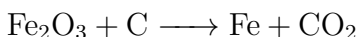

```

1
2 % See page 1 of
3 % https://www.thoughtco.com/definition-of-balanced-equation-and-examples-604380
4 \ce{Fe2O3 + C -> Fe + CO2}

```

For example, in the reaction between sodium chloride (NaCl) and silver nitrate (AgNO_3), the molecular reaction is:

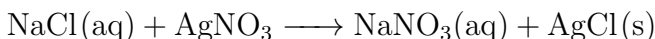

```

1
2 % From page 1 of
3 % https://www.thoughtco.com/definition-of-molecular-equation-605366
4
5 For example, in the reaction between sodium chloride
6 (\ce{NaCl})
7 and silver nitrate
8 (\ce{AgNO3}),
9 the molecular reaction is:
10
11 \ce{NaCl(aq) + AgNO3 -> NaNO3(aq) + AgCl(s)}

```

The complete ionic equation is:

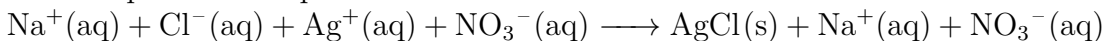

```

1
2 The complete ionic equation is:
3
4 \ce{Na+(aq) + Cl-(aq) + Ag+(aq) + NO3-(aq) -> AgCl(s) + Na+(aq) + NO3-(aq)}

```

Ruben [151, starting at 5:25] claims this equation

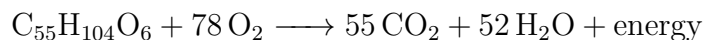

describes weight loss.

```

1
2 Ruben
3 \cite[starting at 5:25]{meerman2013}
4 claims this equation
5 \begin{center}
6 \ce{C55H104O6 + 78O2 -> 55CO2 + 52H2O + energy}\end{center}
7 \end{center}
8 describes weight loss.

```



```

31      & \ce{7802}                % 3.
32      & \ce{->}                % 4.
33      & \ce{55C02}              % 5.
34      & \ce{+}                  % 6.
35      & \ce{52H20}              % 7.
36      & \ce{+}                  % 8.
37      & energy\\                 % 9.
38      %
39      \Fs human fat&             % 1.
40      &                          % 2.
41      \Fs oxygen&               % 3.
42      &                          % 4.
43      \Fs carbon dioxide&       % 5.
44      &                          % 6.
45      \Fs water&                % 7.
46      &                          % 8.
47      \Fs body heat, moving, thinking, growing\\ % 9.
48      \end{tabular}
49      \end{center}

```

V.3 Chemical Figures

Below is an example of how to use the chemfig package [152].
 Here is the chemical figure for Penicillin [152, pages 72–73]

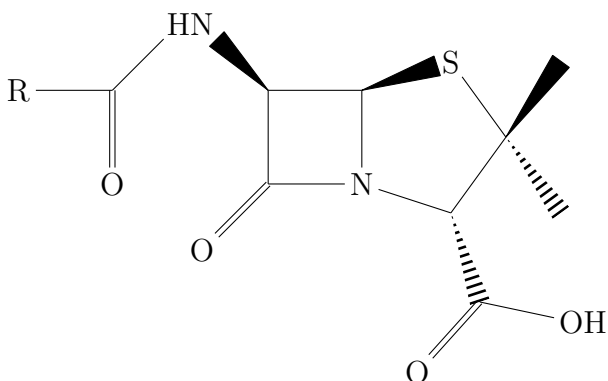

```

1
2
3 \section{Chemical Figures}
4
5 Below is an example of how to use the chemfig package
6 \cite{tellechea2021}.
7
8 % Chicago Manual of Style Online, 17 edition, section 9.61 states
9 % that 72--73, not 72--3, should be used.
10 Here is the chemical figure
11 for Penicillin
12 \cite[pages-72--73]{tellechea2021}\\
13
14 \chemfig{
15   [:-90]HN(-[::-45](-[::-45]R)=[:+45]O)>[:+45]*4(- (=O)-N*5(- (<: (=[::-60]O)
16   -[:+60]OH)-(<[:+0])(<[::-108])>-S>)--)}
17 }

```

V.4 Chemical Schemes

Below are some examples of how to do schemes.

Scheme V.1. This is the first scheme caption.

This is the first scheme.

```
1 \newpage
2 \section{Chemical Schemes}
3
4 Below are some examples of how to do schemes.
5
6 \begin{scheme}[ht]
7   \caption{This is the first scheme caption.}
8   \vspace*{6pt}
9   \begin{center}
10    This is the first scheme.
11   \end{center}
12 \end{scheme}
```

Scheme V.2. This is the second scheme caption.

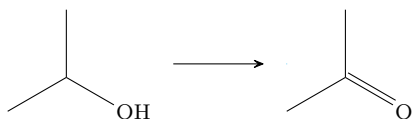

```
1 \begin{scheme}[ht]
2   \caption{This is the second scheme caption.}
3   \vspace*{6pt}
4   \begin{center}
5     % Next line was added to make scheme a little smaller.
6     \scriptsize\setchemfig{bond offset=1pt,atom sep=3em,compound sep=6em}
7     \schemestart
8     \chemfig{-[:30](-[2])-[:30]OH}
9     \arrow
10    \chemfig{-[:30](-[2])=^[:30]O}
11   \schemestop
12   \end{center}
13 \end{scheme}
```

Scheme V.3. The Fischer indole synthesis [152, pages 74–75].

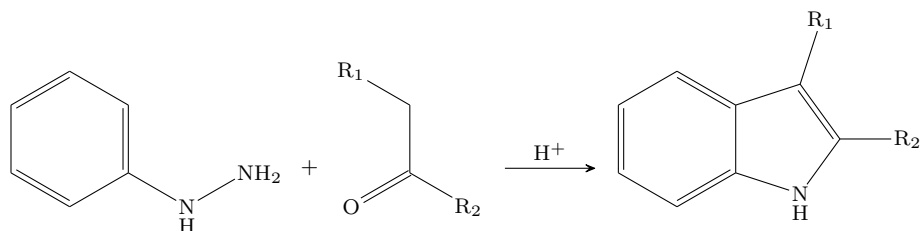

```

1 \newpage
2 \begin{scheme}[ht]
3   \caption[The Fischer indole synthesis]{%
4     The Fischer indole synthesis
5     \cite[pages-74--75]{tellechea2021}.%
6   }
7   \vspace*{6pt}
8   \begin{center}
9     % Next line was added to make scheme a little smaller.
10    \scriptsize\setchemfig{bond offset=1pt,atom sep=3em,compound sep=6em}
11    \schemestart
12    \chemfig{*6(=*6(-\chembelow{N}{H}-NH_2)=-=)}
13    \+
14    \chemfig{([:-150]O)(-[:-30]R_2)-[2]-[:150]R_1}
15    \arrow(.mid east--.mid west){->[\chemfig{H^+}]}
16    \chemfig{*6(=*5(-\chembelow{N}{H}-(-R_2)=(-R_1)-)-==)}
17    \schemestop
18  \end{center}
19 \end{scheme}

```

Scheme V.4. The Cannizzaro reaction [152, pages 77–78].

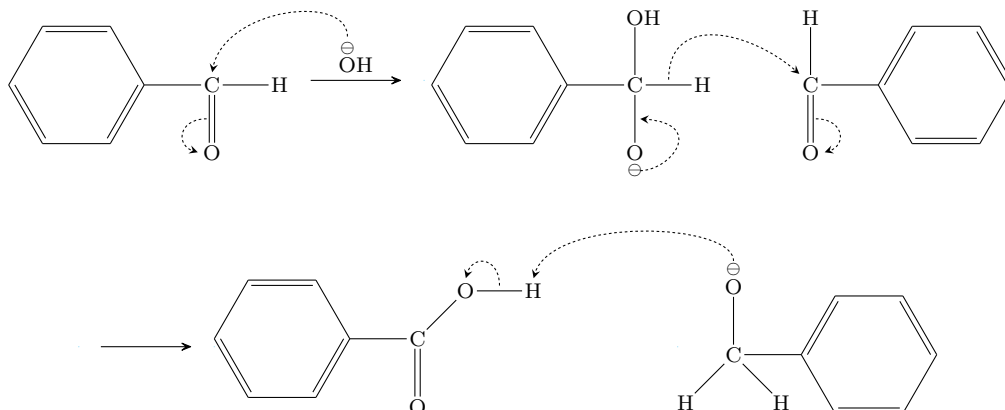

```

1  \newpage
2  \begin{scheme}[ht]
3    \caption[The Cannizzaro reaction.]{%
4      The Cannizzaro reaction
5      \cite[pages-77--78]{tellechea2021}.%
6    }
7    \vspace*{12pt}
8    \begin{center}
9      % Next line was added to make scheme a little smaller.
10     \scriptsize\setchemfig{bond offset=1pt,atom sep=3em,compound sep=6em}
11     \schemestart
12     \chemfig{[: -30]*6(==(-@{atoc}C([6]=[@{db}]@{atoo1}O)-H)-==)}
13     \arrow[start.mid east--.mid west]{->[\chemfig{@{atoo2}\chemabove{0}{\scriptstyle\ominus}}H]}
14     \chemmove[-stealth,shorten >=2pt,dash pattern=on 1pt off 1pt,thin]{
15       \draw[shorten <=8pt](atoo2) ..controls +(up:10mm) and +(up:10mm)..(atoc);
16       \draw[shorten <=2pt](db) ..controls +(left:5mm) and +(west:5mm)..(atoo1);}
17     \chemfig{[: -30]*6(==(-C([6]-[@{sb1}]@{atoo1})\chembelow{0}{\scriptstyle\ominus})
18       ([2]-OH)-[@{sb2}]H)-==)}
19     \hspace{1cm}
20     \chemfig{[: -30]*6((-@{atoc}C([6]=[@{db}]@{atoo2}O)-[2]H)-==)}
21     \chemmove[-stealth,shorten <=2pt,shorten >=2pt,dash pattern=on 1pt off 1pt,thin]{
22       \draw([yshift=-4pt]atoo1.270) ..controls +(0:5mm) and +(right:10mm)..(sb1);
23       \draw(sb2) ..controls +(up:10mm) and +(north west:10mm)..(atoc);
24       \draw(db) ..controls +(right:5mm) and +(east:5mm)..(atoo2);}
25     \arrow{@start.base west--}{0}[-75,2]
26   {}
27   \arrow
28   \chemfig{[: -30]*6(==(-C([1]-@{atoo2}O)-[@{sb}0]@{atoh}H)([6]=O)-==)}
29   \arrow{0}
30   \chemfig{[: -30]*6((-C(-[5]H)(-[7]H)-[2]@{atoo1})\chemabove{0}{\scriptstyle\ominus})-==)}
31   \chemmove[-stealth,shorten >=2pt,dash pattern=on 1pt off 1pt,thin]{
32     \draw[shorten <=7pt](atoo1.90) ..controls +(90:8mm) and +(up:10mm)..(atoh);
33     \draw[shorten <=2pt](sb) ..controls +(up:5mm) and +(up:5mm)..(atoo2);}
34   \schemestop
35   \end{center}
36   \end{scheme}

```

W. COMPUTER SCIENCE

The cryptocode package [153] is used to typeset pseudocode, algorithms, and protocols.

```
1 \chapter{COMPUTER SCIENCE}
2 \ix{computer science//Computer Science appendix}
3
4 The cryptocode package
5 \cite{mittelbach2020}
6 \ix{cryptocode//pseudocode//algorithm//protocol}%
7 is used to typeset pseudocode,
8 algorithms,
9 and protocols.
```

W.1 Protocol examples

Protocol W.1. This is the first protocol caption.

This is the first protocol.

Protocol W.2. This is the second protocol caption.

Alice	Bob
$b \leftarrow \{0, 1\}$	
	$\xrightarrow{\text{send over } b}$
	do something

```
1
2
3 \section{Protocol examples}
4
5 \begin{protocol}[ht]
6   \caption{This is the first protocol caption.}
7   This is the first protocol.
8 \end{protocol}
9
10 \begin{protocol}[ht]
11   \caption{This is the second protocol caption.}
12   \pseudocodeblock
13   {
14     \textbf{Alice} \> \> \textbf{Bob} \\
15     b \sample \bin \> \> \\
16     \> \xrightarrow{\text{send over } b} \> \\
17     \> \> \text{do something}
18   }
19 \end{protocol}
```

X. ELECTRICAL ENGINEERING

```

1 \chapter{ELECTRICAL ENGINEERING}
2 \ix{electrical engineering//Electrical Engineering appendix}

```

X.1 Amplifiers

```

1
2
3 \section{Amplifiers}

```

This 18 W MOSFET amplifier with npn transistor was done by Ramón Jaramillo [154]. This example make uses the CircuiTikZ [155] and siunitx packages.

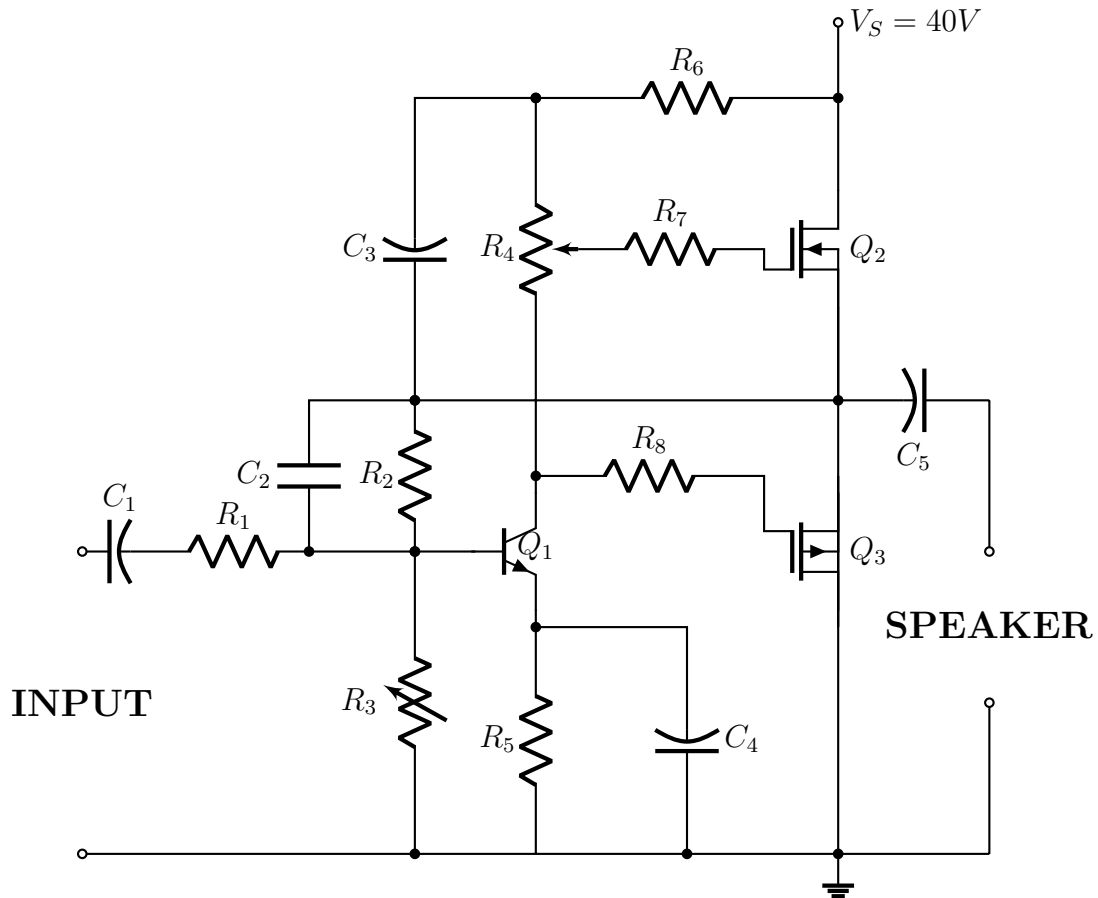

```

1 This \qty{18}{\W} MOSFET amplifier
2 with npn transistor was done by Ram'on Jaramillo
3 \cite{jaramillo}.
4 \ix{Jaramillo, Ram'on}
5 This example make uses the \CircuiTikZLogo\index{\CircuiTikZLogo}
6 \cite{redaelli2021}
7 \ix{Redaelli, Massimo A.}%
8 and siunitx packages.
9
10 \begin{tikzpicture}[scale=2]
11 \draw[color=black, thick]
12 (0,0) to [short,o-] (6,0){} % Baseline for connection to ground
13 % Input and ground

```

```

14      (0,1) node[\large\textbf{INPUT}]
15      % Connection of passive components
16      (5,0) node[ground]{} node[circ](4.5,0){}
17      (0,2) to [cC, l=$C_1$, o-] (0.5,2)
18      to [R,l=$R_1$,] (1.5,2)
19      to node[short]{}(2.6,2)
20      (1.5,2) to [C, l=$C_2$, *-] (1.5,3) -| (5,3)
21      (2.2,2) to [R, l=$R_2$, *-] (2.2,3)
22      (2.2,3) to [cC, l=$C_3$, *-] (2.2,5) -| (3,5)
23      % Transistor Bipolar Q1
24      (3,0) to [R,l=$R_5$,*-] (3,1.5)
25      to [Tnpn,n=npn1] (3,2.5)
26      (npn1.E) node[right=3mm, above=5mm]{$Q_1$} % Labelling the NPN transistor
27      (4,0) to [cC, l=$C_4$, *-] (4, 1.5)--(3,1.5)
28      (2.2,0) to [vR, l=$R_3$, *-] (2.2,2)
29      (3,2.5) to node[short]{}(3,3)
30      (3,5) to [pR, n=pot1, l=$R_4$, *-] (3,3)
31      (3,5) to [R, l=$R_6$, *-] (5,5)
32      to [short,*-o] (5,5.5) node[right]{$V_S=40$ V$}
33      % Mosfet Transistors
34      (5,3) to [Tnigfetd,n=mos1] (5,5)
35      (mos1.B) node[anchor=west]{$Q_2$} % Labelling MOSFET Q2 Transistor
36      (pot1.wiper) to [R, l=$R_7$] (4.5,4) -| (mos1.G)
37      (5,1.5) to [Tpigfetd,n=mos2] (5,2.5)
38      (5,0) to (mos2.S)
39      (3,2.5) to [R, l=$R_8$, *-] (4.5,2.5)
40      -| (mos2.G)
41      (mos2.B) node[anchor=west]{$Q_3$} % Labelling MOSFET Q3 Transistor
42      % Output
43      (6,3) to [cC, l=$C_5$,*-] (5,3)
44      (6,3) to [short,-o] (6,2){}
45      (mos1.S)--(mos2.D)
46      (6,0) to [short,-o] (6,1){} node[above=7mm]{\large\textbf{SPEAKER}}
47      ;
48      \end{tikzpicture}

```

X.2 Kalman Filter System Model

This Kalman filter system model was done by Burkart Lingner [156].

```

1
2
3      \section{Kalman Filter System Model}
4
5      This Kalman filter system model was done by Burkart Lingner
6      \cite{lingner2010}.
7      \ix{Lingner, Burkart}
8
9      % An example using TikZ/PGF 2.00
10     %
11     % Features: Decorations, Fit, Layers, Matrices, Styles
12     % Tags: Block diagrams, Diagrams
13     % Technical area: Electrical engineering
14
15     %%% \documentclass[a4paper,10pt]{article}
16     %%%
17     %%% \usepackage[english]{babel}
18     %%% \usepackage[T1]{fontenc}
19     %%% \usepackage[ansinew]{inputenc}
20     %%%
21     %%% \usepackage{lmodern}          % font definition

```

Figure X.1. Kalman filter system model

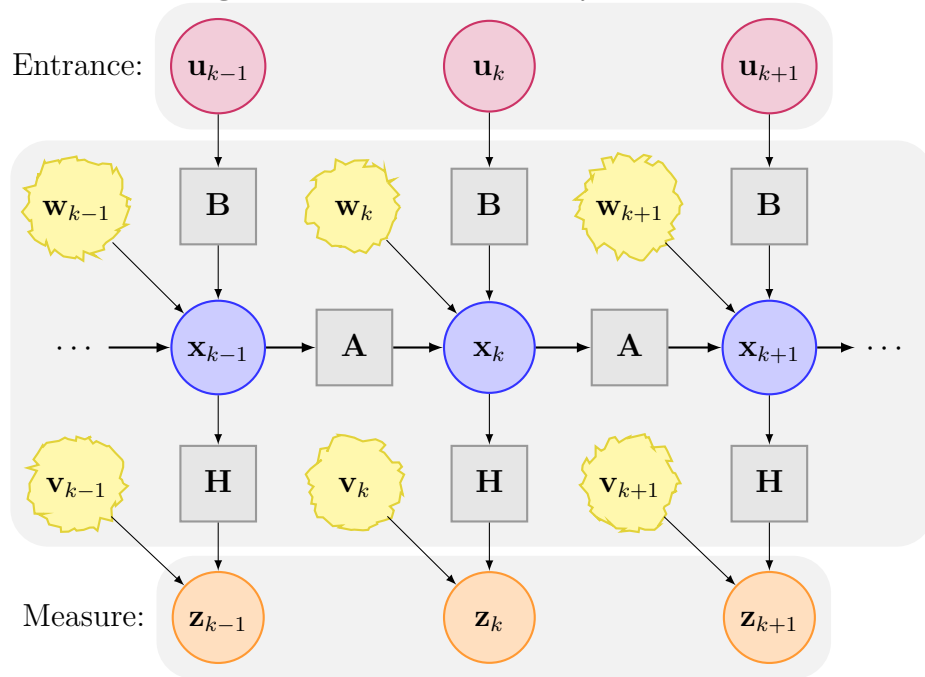

```

22 %%%% \usepackage{amsmath}          % math fonts
23 %%%% \usepackage{amsthm}
24 %%%% \usepackage{amsfonts}
25 %%%%
26 %%%% \usepackage{tikz}
27 %%%%
28 %%%% %%%<
29 %%%% \usepackage{verbatim}
30 %%%% \usepackage[active,tightpage]{preview}
31 %%%% \PreviewEnvironment{tikzpicture}
32 %%%% \setlength\PreviewBorder{5pt}%
33 %%%% %%%>
34 %%%%
35 %%%% \begin{comment}
36 %%%% :Title: Kalman Filter System Model
37 %%%% :Slug: kalman-filter
38 %%%% :Author: Burkart Lingner
39 %%%%
40 %%%% This is the system model of the (linear) Kalman filter.
41 %%%%
42 %%%% \end{comment}
43 %%%%
44 %%%%
45
46 \begin{figure}[htbp]
47 \caption{Kalman filter system model}
48 \centering
49 % The state vector is represented by a blue circle.
50 % "minimum size" makes sure all circles have the same size
51 % independently of their contents.
52 \tikzstyle{state}=[circle,
53
54
55
56
57
58
59
60
61
62
63
64
65
66
67
68
69
70
71
72
73
74
75
76
77
78
79
80
81
82
83
84
85

```

```

86             minimum size=1.2cm,
87             draw=yellow!85!black,
88             fill=yellow!40,
89             decorate,
90             decoration={random steps,
91                         segment length=2pt,
92                         amplitude=2pt}]
93
94 % Everything is drawn on underlying gray rectangles with
95 % rounded corners.
96 \tikzstyle{background}=[rectangle,
97                         fill=gray!10,
98                         inner sep=0.2cm,
99                         rounded corners=5mm]
100
101 \begin{tikzpicture}[>=latex,text height=1.5ex,text depth=0.25ex]
102     % "text height" and "text depth" are required to vertically
103     % align the labels with and without indices.
104
105     % The various elements are conveniently placed using a matrix:
106     \matrix[row sep=0.5cm,column sep=0.5cm] {
107         % First line: Control input
108         &
109         \node (u_{k-1}) [input] {\mathbf{u}_{k-1}}; &
110         &
111         \node (u_k) [input] {\mathbf{u}_k}; &
112         &
113         \node (u_{k+1}) [input] {\mathbf{u}_{k+1}}; &
114         \\
115         % Second line: System noise & input matrix
116         \node (w_{k-1}) [noise] {\mathbf{w}_{k-1}}; &
117         \node (B_{k-1}) [matrix] {\mathbf{B}}; &
118         \node (w_k) [noise] {\mathbf{w}_k}; &
119         \node (B_k) [matrix] {\mathbf{B}}; &
120         \node (w_{k+1}) [noise] {\mathbf{w}_{k+1}}; &
121         \node (B_{k+1}) [matrix] {\mathbf{B}}; &
122         \\
123         % Third line: State & state transition matrix
124         \node (A_{k-2}) {\cdots}; &
125         \node (x_{k-1}) [state] {\mathbf{x}_{k-1}}; &
126         \node (A_{k-1}) [matrix] {\mathbf{A}}; &
127         \node (x_k) [state] {\mathbf{x}_k}; &
128         \node (A_k) [matrix] {\mathbf{A}}; &
129         \node (x_{k+1}) [state] {\mathbf{x}_{k+1}}; &
130         \node (A_{k+1}) {\cdots}; & \\
131         % Fourth line: Measurement noise & measurement matrix
132         \node (v_{k-1}) [noise] {\mathbf{v}_{k-1}}; &
133         \node (H_{k-1}) [matrix] {\mathbf{H}}; &
134         \node (v_k) [noise] {\mathbf{v}_k}; &
135         \node (H_k) [matrix] {\mathbf{H}}; &
136         \node (v_{k+1}) [noise] {\mathbf{v}_{k+1}}; &
137         \node (H_{k+1}) [matrix] {\mathbf{H}}; &
138         \\
139         % Fifth line: Measurement
140         &
141         \node (z_{k-1}) [measurement] {\mathbf{z}_{k-1}}; &
142         &
143         \node (z_k) [measurement] {\mathbf{z}_k}; &
144         &
145         \node (z_{k+1}) [measurement] {\mathbf{z}_{k+1}}; &
146         \\
147     };
148
149     % The diagram elements are now connected through arrows:

```

```

150 \path[->]
151     (A_k-2) edge[thick] (x_k-1)           % The main path between the
152     (x_k-1) edge[thick] (A_k-1)         % states via the state
153     (A_k-1) edge[thick] (x_k)           % transition matrices is
154     (x_k) edge[thick] (A_k)             % accentuated.
155     (A_k) edge[thick] (x_k+1)           % x -> A -> x -> A -> ...
156     (x_k+1) edge[thick] (A_k+1)
157
158     (x_k-1) edge (H_k-1)                 % Output path x -> H -> z
159     (H_k-1) edge (z_k-1)
160     (x_k) edge (H_k)
161     (H_k) edge (z_k)
162     (x_k+1) edge (H_k+1)
163     (H_k+1) edge (z_k+1)
164
165     (v_k-1) edge (z_k-1)                 % Output noise v -> z
166     (v_k) edge (z_k)
167     (v_k+1) edge (z_k+1)
168
169     (w_k-1) edge (x_k-1)                 % System noise w -> x
170     (w_k) edge (x_k)
171     (w_k+1) edge (x_k+1)
172
173     (u_k-1) edge (B_k-1)                 % Input path u -> B -> x
174     (B_k-1) edge (x_k-1)
175     (u_k) edge (B_k)
176     (B_k) edge (x_k)
177     (u_k+1) edge (B_k+1)
178     (B_k+1) edge (x_k+1)
179     ;
180
181 % Now that the diagram has been drawn, background rectangles
182 % can be fitted to its elements. This requires the TikZ
183 % libraries "fit" and "background".
184 % Control input and measurement are labeled. These labels have
185 % not been translated to English as "Measurement" instead of
186 % "Messung" would not look good due to it being too long a word.
187 \begin{pgfonlayer}{background}
188     \node [background,
189           fit=(u_k-1) (u_k+1),
190           label=left:Entrance:] {};
191     \node [background,
192           fit=(w_k-1) (v_k-1) (A_k+1)] {};
193     \node [background,
194           fit=(z_k-1) (z_k+1),
195           label=left:Measure:] {};
196 \end{pgfonlayer}
197 \end{tikzpicture}
198
199 \end{figure}

```

Y. LINGUISTICS

See WIKIBOOKS \LaTeX /Linguistics [157] or google for the information you need.

The doulossil font [158] is a TrueType font. Version 0.1 on September 21, 2020 claimed “it has characters that are not in other TeX IPA fonts”.

```
1 \chapter{LINGUISTICS}
2 \ix{linguistics//Linguistics appendix}
3
4 See WIKIBOOKS \LaTeX/Linguistics \cite{wikibooks-latex-linguistics}
5 or google for the information you need.
6
7 The doulossil font
8 \cite{tambe2020}
9 is a TrueType font.
10 Version 0.1 on September 21, 2020 claimed
11 ‘‘it has characters that are not in other TeX IPA fonts’’.
```

Y.1 Demonstrate the example and examples environments

The example and examples environment are defined in the covington [159] package. Demonstrate the example environment:

.1) This is an example. This is an example.

Demonstrate the examples environment:

.2) First example.

.3) Second example.

```
1
2
3 \section{Demonstrate the example and examples environments}
4
5 The example and examples environment
6 are defined
7 in the covington
8 \cite{covington2021}
9 package.
10
11 Demonstrate the example environment:
12 \begin{example}
13   This is an example.
14   This is an example.
15 \end{example}
16
17 Demonstrate the examples environment:
18 \begin{examples}
19   \item First example.
20   \item Second example.
21 \end{examples}
```

Z. MATHEMATICS

PurdueThesis loads the AMSmath package [160] to do mathematics.

```
1 \chapter{MATHEMATICS}
2 \ix{mathematics//Mathematics appendix}
3
4 \PurdueThesisLogo\ loads the \AMSMathLogo\ package
5 \cite{amslatex3project2019}
6 to do mathematics.
```

There are two types of mathematics in L^AT_EX. Text math is math that that is interspersed with text. For example, this is text math: $a = b + c$. This is display math:

$$a = b + c \tag{Z.1}$$

```
1 There are two types of mathematics in \LaTeX.
2 Text math is math that that is interspersed with text.
3 For example, this is text math: \(\a = b + c\).
4 This is display math:
5 \begin{equation}
6   \a = b + c
7 \end{equation}
```

Z.1 Standard Functions

Standard functions should be in a roman font. Like this: $\cos \theta$. Here is a list of standard function commands:

<code>\arccos</code>	<code>\csc</code>	<code>\ker</code>	<code>\min</code>
<code>\arcsin</code>	<code>\deg</code>	<code>\lg</code>	<code>\Pr</code>
<code>\arctan</code>	<code>\det</code>	<code>\lim</code>	<code>\sec</code>
<code>\arg</code>	<code>\dim</code>	<code>\liminf</code>	<code>\sin</code>
<code>\cos</code>	<code>\exp</code>	<code>\limsup</code>	<code>\sinh</code>
<code>\cosh</code>	<code>\gcd</code>	<code>\ln</code>	<code>\sup</code>
<code>\cot</code>	<code>\hom</code>	<code>\log</code>	<code>\tan</code>
<code>\coth</code>	<code>\inf</code>	<code>\max</code>	<code>\tanh</code>

```

1  \newpage
2
3  \section{Standard Functions}
4
5  Standard functions should be in a roman font.
6  Like this:  $\cos \theta$ .
7  Here is a list of standard function commands:\\
8
9  % The "@{\hspace*{\parindent}}" indents the table
10 % the same amount as a paragraph.
11 \begin{tabular}{@{\hspace*{\parindent}}llll@{}}
12   \verb+\arccos+& \verb+\csc+& \verb+\ker+& \verb+\min+\\
13   \verb+\arcsin+& \verb+\deg+& \verb+\lg+& \verb+\Pr+\\
14   \verb+\arctan+& \verb+\det+& \verb+\lim+& \verb+\sec+\\
15   \verb+\arg+& \verb+\dim+& \verb+\liminf+& \verb+\sin+\\
16   \verb+\cos+& \verb+\exp+& \verb+\limsup+& \verb+\sinh+\\
17   \verb+\cosh+& \verb+\gcd+& \verb+\ln+& \verb+\sup+\\
18   \verb+\cot+& \verb+\hom+& \verb+\log+& \verb+\tan+\\
19   \verb+\coth+& \verb+\inf+& \verb+\max+& \verb+\tanh+\\
20 \end{tabular}
21 \ix
22 {%
23   arccos//arcsin//arctan//arg//cos//cosh//cot//coth%
24   //csc//deg//det//dim//exp//gcd//hom//inf%
25   //ker//lg//lim//liminf//limsup//ln//log//max%
26   //min//Pr//sec//sin//sinh//sup//tan//tanh%
27 }
28 \index{\verb+\arccos+} \index{\verb+\arcsin+} \index{\verb+\arctan+} \index{\verb+\arg+}
29 \index{\verb+\cos+} \index{\verb+\cosh+} \index{\verb+\cot+} \index{\verb+\coth+}
30 \index{\verb+\csc+} \index{\verb+\deg+} \index{\verb+\det+} \index{\verb+\dim+}
31 \index{\verb+\exp+} \index{\verb+\gcd+} \index{\verb+\hom+} \index{\verb+\inf+}
32 \index{\verb+\ker+} \index{\verb+\lg+} \index{\verb+\lim+} \index{\verb+\liminf+}
33 \index{\verb+\limsup+} \index{\verb+\ln+} \index{\verb+\log+} \index{\verb+\max+}
34 \index{\verb+\min+} \index{\verb+\Pr+} \index{\verb+\sec+} \index{\verb+\sin+}
35 \index{\verb+\sinh+} \index{\verb+\sup+} \index{\verb+\tan+} \index{\verb+\tanh+}

```

Z.2 English Words in Math

English words in math should be in a roman font like this:

Let the maximum value of a be a_{\max} .

$a_{\max} \geq a_{\min}$ should always be true.

The temperature in the attic is t_{attic} .

```
1 \newpage
2
3 \section{English Words in Math}
4
5 English words in math should be in a roman font like this:\\
6 Let the maximum value of \(\a\) be \(\a_{\text{max}}\).\\
7 \(\a_{\text{max}} \geq a_{\text{min}}\) should always be true.\\
8 The temperature in the attic is \(\t_{\text{attic}}\).
```

Z.3 Text Math

Use \(to start text math and \) to end text math. Some people use $\text{\$}$ to start and end text math—I don't recommend that because L^AT_EX can give better error messages if you use \(and \) .

```
1 \section{Text Math}
2
3 Use \verb+\(+ to start text math and \verb+\)+ to end text math.
4 Some people use \verb+\$+ to start and end text math---I don't
5 recommend that because \LaTeX\ can give better error messages
6 if you use \verb+\(+ and \verb+\)+.
```

Z.4 Displayed Equations

Do not use $\text{\$}$ to start or end displayed math like T_EX uses [161].

The AMSmath package provides a number of additional displayed equation structures beyond the ones provided in basic L^AT_EX. The augmented set includes [162]:

Environment	Used for
equation	used for single equations
multline	split single equations over multiple lines
gather	collect but do not align multiple equations
align	align multiple equations
alignat	aligns multiple equations at multiple places
flalign	aligns multiple equations at multiple places on full length lines
split	split a single equation over multiple lines

All but `split` can be followed by `*` to not number equations.

```
1 \section{Displayed Equations}
2
3 Do not use \verb+\$+ to start or end displayed math like \TeX\ uses
4 \cite{gratzer2016}.
5
```

```

6 The \AMSMathLogo\ package provides a number
7 of additional displayed equation structures
8 beyond the ones provided in basic \LaTeX.
9 The augmented set includes
10 \cite{amslatex3project2019b}:
11
12 \hbox to\hsize{%
13   \hss
14   \begin{tabular}{@{}ll@{}}
15     \toprule
16     \bfseries Environment& \bfseries Used for\\
17     \midrule
18     \tt equation& used for single equations\\
19     \tt multline& split single equations over multiple lines\\
20     \tt gather& collect but do not align multiple equations\\
21     \tt align& align multiple equations\\
22     \tt alignat& aligns multiple equations at multiple places\\
23     \tt flalign& aligns multiple equations at multiple places on full length lines\\
24     \tt split& split a single equation over multiple lines\\
25     \bottomrule
26   \end{tabular}%
27   \hss
28 }
29
30 All but \verb+split+ can be followed by \verb+*+ to not number equations.

```

Z.4.1 equation environment

The `equation` environment is used for single equations.

$$E = mc^2 \tag{Z.2}$$

```

1
2 \subsection{\texttt{equation} environment}
3
4 The \verb+equation+ environment is used for single equations.
5
6 \begin{equation}
7   E = mc^2
8 \end{equation}

```

The `equation*` environment does single, unnumbered equations.

$$a = b_0c + \frac{1}{2}de^2 + \frac{1}{2}fg^2 + h_1 + h_2 + \cdots + h_n \quad \text{for } c \neq d \text{ and } g < \infty$$

```

1
2 The \verb+equation*+ environment does single, unnumbered equations.
3
4 \begin{equation*}
5   a = b_0c + \frac{1}{2}de^2 + {\textstyle \frac{1}{2}} fg^2
6   + h_1 + h_2 + \cdots + h_n
7   \quad \text{\texttt{for } \texttt{(c \ne d)} and \texttt{(g < \infty)}}
8 \end{equation*}

```

Greene [163] wrote For [#PiDay](#), one of the coolest formulae for today's honoree:

$$\frac{1}{\pi} = \frac{\sqrt{8}}{9801} \sum_{n=0}^{\infty} \frac{(4n!)(1103 + 26390n)}{(n!)^4 396^{4n}}$$

```

1
2 \textcite{greene-2021-03-14}
3 wrote
4 % \begin{quotation}
5 For
6 \href{https://twitter.com/hashtag/PiDay?src=hashtag_click\#PiDay}{\#PiDay},
7 one of the coolest formulae for today's honoree:
8 \[
9 \frac{1}{\pi}
10 =
11 \frac{\sqrt[8]{9801}}{\sum_{n=0}^{\infty} \frac{(4n)! (1103+26390n)}{(n!)^4 396^{4n}}}
12 \]
13
14 \end{quotation}
15

```

International standard ISO 80000-2:2019 [164] states that e , i , j , and π should appear as e , i , j and π because they are constants. This is done automatically by the `pa-mismath` package that is loaded by `thesis.tex`. See `thesis.tex` for more information, including what to do if you're not using those as constants.

Euler's identity is

$$e^{i\pi} + 1 = 0.$$

```

1
2 International standard ISO 80000-2:2019
3 \cite{iso8000022019}
4 states that  $e$ ,  $i$ ,  $j$ ,
5 and  $\pi$  should appear as
6  $e$ ,  $i$ ,  $j$ 
7 and  $\pi$  because they are constants.
8 This is done automatically by the pa-mismath package
9 that is loaded by thesis.tex.
10 See thesis.tex for more information,
11 including what to do if you're not using those as constants.
12
13 Euler's identity is
14 \begin{equation*}
15 e^{i\pi} + 1 = 0.
16 \end{equation*}

```

Here's a simple formula relating e , i , π , and ϕ , the golden ratio

$$e^{i\pi} + 2\phi = \sqrt{5}. \tag{Z.3}$$

I didn't notice anything on the web about putting the symbol for the golden ratio in a special font even though it is a constant.

```

1
2 Here's a simple formula relating  $e$ ,  $i$ ,  $\pi$ , and  $\phi$ ,
3 the golden ratio
4 \begin{equation}
5 e^{i\pi} + 2\phi = \sqrt{5}.
6 \end{equation}
7 I didn't notice anything on the web about putting the symbol for
8 the golden ratio in a special font even though it is a constant.

```

International standard ISO 80000-2:2019 [164] states that the “*d*” in math differentials should be typeset as “*d*”. So,

$$\text{use } \int x \, dx \qquad \text{instead of } \int x \, dx$$

```

1
2 International standard ISO 80000-2:2019
3 \cite{iso8000022019}
4 states that the ‘‘$d/$’’ in math differentials
5 should be typeset as ‘‘$di$’’.
6 So,
7 \begin{equation*}
8   \text{\text{use } \int x\,di x\qquad\qquad \text{instead of } \int x\,dx}
9 \end{equation*}

```

The formula for Bekenstein-Hawking entropy:

$$S_{\text{BH}} = \frac{A}{4L_P^2} = \frac{c^3 A}{4G\hbar}$$

```

1
2 The formula for Bekenstein-Hawking entropy:
3
4 \begin{equation*}
5   S_{\text{BH}}
6   =
7   \frac{A}{4L_P^2}
8   = \frac{c^3 A}{4G\hbar}
9 \end{equation*}

```

Type in the math and let L^AT_EX worry about the spacing. You only need to do fine tuning by hand if it looks bad.

Another `equation*` environment, note the spacing before the large close parenthesis:

$$\frac{a}{b} = ab^{-1} = \left(\sqrt{\frac{a}{b}}\right)^2 = \left(\sqrt{\frac{a}{b}}\right)^2 = \left(\sqrt{\frac{a}{b}}\right)^2 = \left(\sqrt{\frac{a}{b}}\right)^2 = \left(\sqrt{\frac{a}{b}}\right)^2 = \left(\sqrt{\frac{a}{b}}\right)^2$$

```

1
2 Type in the math and let \LaTeX\ worry about the spacing.
3 You only need to do fine tuning by hand if it looks bad.
4
5 Another \verb+equation*+ environment,
6 note the spacing before the large close parenthesis:
7
8 \begin{equation*}
9   \frac{ab
10  = ab^{-1}
11  % Prens are the wrong size.
12  = (\sqrt{\frac{ab}})^2
13  % Prens are the right size but closing paren is too close to radical.
14  = \left( \sqrt{\frac{ab}{}} \right)^2
15  % Prens are right size but a negative thin space puts closing paren on top of radical.
16  = \left( \sqrt{\frac{ab}{}} \right)^2
17  % Prens are right size but a thin space puts closing paren too close to radical.
18  = \left( \sqrt{\frac{ab}{}} \right)^2
19  % Prens are right size but a medium space puts closing paren too close to radical.
20  = \left( \sqrt{\frac{ab}{}} \right)^2
21  % Prens are right size and I think a thick space looks the best.
22  = \left( \sqrt{\frac{ab}{}} \right)^2
23 \end{equation*}

```

$$(\cos x)^2 + (\sin x)^2 = \cos^2 x + \sin^2 x = 1$$

```

1
2 \begin{equation*}
3   (\cos x)^2 + (\sin x)^2 = \cos^2 x + \sin^2 x = 1
4 \end{equation*}

```

$$x \bmod 2 = \begin{cases} 0 & \text{if } x \text{ is even} \\ 1 & \text{if } x \text{ is odd} \end{cases} \quad (\text{Z.4})$$

```

1
2 \begin{equation}
3   x \bmod 2 =
4   \begin{cases}
5     0 & \text{\text{if } \$x\$ is even}\backslash\backslash
6     1 & \text{\text{if } \$x\$ is odd}\backslash\backslash
7   \end{cases}
8 \end{equation}

```

The first six derivatives of distance are velocity, acceleration, jerk, snap, crackle, and pop [165].

$$\text{distance derivatives} = \begin{cases} x = \text{distance} & = vt \\ v = \text{velocity} & = \frac{dx}{dt} \\ a = \text{acceleration} & = \frac{dv}{dt} = \frac{d^2x}{dt^2} \\ j = \text{jerk} & = \frac{da}{dt} = \frac{d^2v}{dt^2} = \frac{d^3x}{dt^3} \\ s = \text{snap} & = \frac{dj}{dt} = \frac{d^2a}{dt^2} = \frac{d^3v}{dt^3} = \frac{d^4x}{dt^4} \\ c = \text{crackle} & = \frac{ds}{dt} = \frac{d^2j}{dt^2} = \frac{d^3a}{dt^3} = \frac{d^4v}{dt^4} = \frac{d^5x}{dt^5} \\ p = \text{pop} & = \frac{dc}{dt} = \frac{d^2s}{dt^2} = \frac{d^3j}{dt^3} = \frac{d^4a}{dt^4} = \frac{d^5v}{dt^5} = \frac{d^6x}{dt^6} \end{cases} \quad (\text{Z.5})$$

```

1
2 The first six derivatives of distance are velocity, acceleration, jerk, snap, crackle,
3 and pop
4 \cite{reid2013}.
5
6 \begin{equation}
7   % Every array element should be in \displaystyle (a big font).
8   \AtBeginEnvironment{array}{\everymath{\displaystyle}}
9   % Set space between columns to zero, use {} = ... to add a little space before the = "by hand".
10  \arraycolsep = 0pt
11  \text{distance derivatives} = \left\{ \left[ \begin{array}{l}
12    \begin{array}{l}
13      % I'm formatting the first 4 lines different from the last 3 so this will fit on one page.
14      x & {} = \text{distance} & {} = vt \backslash\backslash[2pt]

```



```

15     v&      {}=\text{velocity}&      {}=\frac{\di x}{\di t}\[9pt]
16     a&      {}=\text{acceleration}& {}=\frac{\di v}{\di t}& {}=\frac{\di^2x}{\di t^2}\[9pt]
17     \mit j& {}=\text{jerk}&      {}=\frac{\di a}{\di t}& {}=\frac{\di^2v}{\di t^2}&
18     {}=\frac{\di^3x}{\di t^3}\[9pt]
19     s
20     & {}=\text{snap}
21     & {}=\frac{\di \mit j}{\di t}
22     & {}=\frac{\di^2a}{\di t^2}
23     & {}=\frac{\di^3v}{\di t^3}
24     & {}=\frac{\di^4x}{\di t^4}\[9pt]
25     c
26     & {}=\text{crackle}
27     & {}=\frac{\di s}{\di t}
28     & {}=\frac{\di^2\mit j}{\di t^2}
29     & {}=\frac{\di^3a}{\di t^3}
30     & {}=\frac{\di^4v}{\di t^4}
31     & {}=\frac{\di^5x}{\di t^5}\[9pt]
32     p
33     & {}=\text{pop}
34     & {}=\frac{\di c}{\di t}
35     & {}=\frac{\di^2s}{\di t^2}
36     & {}=\frac{\di^3\mit j}{\di t^3}
37     & {}=\frac{\di^4a}{\di t^4}
38     & {}=\frac{\di^5v}{\di t^5}
39     & {}=\frac{\di^6x}{\di t^6}
40     \end{array}
41     \right.
42     \end{equation}

```

Z.4.2 multiline environment

The multiline environment is used to split single equations over multiple lines.

$$\begin{aligned}
 S = a + b + c + d + e + f + g + h + i + j \\
 + k + l + m + n + o + p \\
 + q + r + s + t + u + v + w + x + y + z \quad (\text{Z.6})
 \end{aligned}$$

```

1
2 \subsection{\texttt{multiline} environment}
3
4 The \verb+multiline+ environment is used
5 to split single equations over multiple lines.
6
7 \begin{multiline}
8     S = a + b + c + d + e + f + g + h + i + j \\
9     + k + l + m + n + o + p \\
10    + q + r + s + t + u + v + w + x + y + z
11 \end{multiline}

```

$$\begin{aligned}
S &= a + b + c + d + e \\
&\quad + f + g + h + i + j \\
&\quad + k + l + m + n + o \\
&\quad + p + q + r + s + t \\
&\quad + u + v + w + x + y \\
&\quad + z \tag{Z.7}
\end{aligned}$$

```

1
2 \begin{multline}
3   S = a + b + c + d + e\\
4   + f + g + h + i + j\\
5   + k + l + m + n + o\\
6   + p + q + r + s + t\\
7   + u + v + w + x + y\\
8   + z
9 \end{multline}

```

$$\begin{aligned}
S &= a + b + c + d + e \\
&\quad + f + g + h + i + j \\
&\quad\quad + k + l + m + n + o \\
&\quad\quad\quad + p + q + r + s + t \\
&\quad\quad\quad\quad + u + v + w + x + y \\
&\quad\quad\quad\quad + z \tag{Z.8}
\end{aligned}$$

```

1
2 % Calculate width of space before equation plus equation number.
3 % (All digits are the same width.)
4 \newdimen{\tdimen}
5 \settowidth{\tdimen}{\kern\multlinetaggap (L.5)}
6 \begin{multline}
7   S = a + b + c + d + e\\
8   \makebox[\textwidth]{\hfill $+ f + g + h + i + j$\hfill\hfill\hfill\hfill\kern\tdimen}\\
9   \makebox[\textwidth]{\hfill\hfill$+ k + l + m + n + o$\hfill\hfill\hfill\kern\tdimen}\\
10  \makebox[\textwidth]{\hfill\hfill\hfill$+ p + q + r + s + t$\hfill\hfill\kern\tdimen}\\
11  \makebox[\textwidth]{\hfill\hfill\hfill\hfill$+ u + v + w + x + y$\hfill\kern\tdimen}\\
12  + z
13 \end{multline}

```

Z.4.3 gather environment

The `gather` environment collects but does not align multiple equations.

$$a = b + c + d + e + f + g + h + i + j + k + l \tag{Z.9}$$

$$m = n + o + p + q + r + s + t + u + v + w + x + y + z \tag{Z.10}$$

```

1
2 \subsection{\texttt{gather} environment}
3
4 The \verb+gather+ environment collects but does not align multiple equations.
5
6 \begin{gather}
7   a = b + c + d + e + f + g + h + i + j + k + l \\
8   m = n + o + p + q + r + s + t + u + v + w + x + y + z
9 \end{gather}

```

$$\begin{aligned}
 a &= b + c + d + e + f + g + h + i + j + k + l \\
 m &= n + o + p + q + r + s + t + u + v + w + x + y + z
 \end{aligned}
 \tag{Z.11}$$

```

1
2 \begin{gather}
3   a = b + c + d + e + f + g + h + i + j + k + l \notag \\
4   m = n + o + p + q + r + s + t + u + v + w + x + y + z
5 \end{gather}

```

$$\begin{aligned}
 \alpha &= \beta + \gamma + \delta + \eta \\
 \theta &= \iota + \kappa + \lambda + \mu + \nu + \rho + \tau
 \end{aligned}$$

```

1
2 \begin{gather*}
3   \alpha = \beta + \gamma + \delta + \eta \\
4   \theta = \iota + \kappa + \lambda + \mu + \nu + \rho + \tau
5 \end{gather*}

```

$$x_{\min} + x_{\max} \leq \sum_{i=1}^n x_i
 \tag{Z.12}$$

$$x_{\min} + x_{\max} = \sum_{i=1}^n x_i - \sum_{i=2}^{n-1} x_i \quad \text{if } x \text{ is sorted}
 \tag{Z.13}$$

$$x_{\min} \leq \left(\sum_{i=1}^n x_i \right) / n
 \tag{Z.14}$$

```

1
2 \begin{gather}
3   x_{\text{\texttt{min}}} + x_{\text{\texttt{max}}} \le \sum_{i=1}^n x_i \\
4   x_{\text{\texttt{min}}} + x_{\text{\texttt{max}}} \\
5   = \sum_{i=1}^n x_i - \sum_{i=2}^{n-1} x_i \quad \text{\texttt{if } \$x\$ is sorted} \\
6   x_{\text{\texttt{min}}} \le \left( \sum_{i=1}^n x_i \right) / n
7 \end{gather}

```

Z.4.4 align environment

The align environment aligns multiple equations.

$$a = b + c + d \tag{Z.15}$$

$$e = f + g + h + i + j \tag{Z.16}$$

```

1
2 \subsection{\texttt{align} environment}
3
4 The \verb+align+ environment aligns multiple equations.
5
6 \begin{align}
7   a &= b + c + d \\
8   e &= f + g + h + i + j
9 \end{align}

```

$$x = \frac{-b \pm \sqrt{b^2 - 4ac}}{2a}$$

$$x = \frac{-b \pm \sqrt{b^2 - 4ac}}{2a} \tag{Z.17}$$

```

1
2 \begin{align}
3   x = \frac{-b \pm \sqrt{b^2-4ac}}{2a}\notag \\
4   % Put a thin space before the b^2 to improve the appearance.
5   x = \frac{-b \pm \sqrt{\,b^2-4ac}}{2a}
6 \end{align}

```

Quadratic formula proof [166]:

$$ax^2 + bx + c = 0 \tag{Z.18}$$

$$\begin{aligned}
 ax^2 + bx &= -c \\
 x^2 + \frac{b}{a}x &= -\frac{c}{a} \\
 x^2 + \frac{b}{a}x + \frac{b^2}{4a^2} &= \frac{b^2}{4a^2} - \frac{c}{a} \\
 \left(x + \frac{b}{2a}\right)^2 &= \frac{b^2}{4a^2} - \frac{c}{a} \\
 \left(x + \frac{b}{2a}\right)^2 &= \frac{b^2}{4a^2} - \frac{4ac}{4a^2} \\
 \left(x + \frac{b}{2a}\right)^2 &= \frac{b^2 - 4ac}{4a^2} \\
 \sqrt{\left(x + \frac{b}{2a}\right)^2} &= \sqrt{\left(\frac{b^2 - 4ac}{4a^2}\right)} \\
 x + \frac{b}{2a} &= \pm \frac{\sqrt{b^2 - 4ac}}{\sqrt{4a^2}} \\
 x + \frac{b}{2a} &= \pm \frac{\sqrt{b^2 - 4ac}}{2a} \\
 x &= -\frac{b}{2a} \pm \frac{\sqrt{b^2 - 4ac}}{2a} \\
 x &= \frac{-b \pm \sqrt{b^2 - 4ac}}{2a} \tag{Z.19}
 \end{aligned}$$

```

1
2 Quadratic formula proof
3 \cite{khan2018}:
4 \ix{quadratic formula}
5
6 % The align environment requires the amsmath package.
7 % Use \addtolength{\jot}{6pt} to increase the space between rows in an amsmath multi-line math formula.
8 % That's not done here so everything will fit on one page.
9 \begin{align}
10 ax^2 + bx + c &= 0 \\
11 ax^2 + bx &= -c \notag \\
12 % The "\," adds a thinspace of horizontal space.
13 x^2 + \frac{b}{a}x &= -\frac{c}{a} \notag \\
14 x^2 + \frac{b}{a}x + \frac{b^2}{4a^2} &= \frac{b^2}{4a^2} - \frac{c}{a} \notag \\
15 \left(x + \frac{b}{2a}\right)^2 &= \frac{b^2}{4a^2} - \frac{c}{a} \notag \\
16 \left(x + \frac{b}{2a}\right)^2 &= \frac{b^2}{4a^2} - \frac{4ac}{4a^2} \notag \\
17 \left(x + \frac{b}{2a}\right)^2 &= \frac{b^2 - 4ac}{4a^2} \notag \\
18 \sqrt{\left(x + \frac{b}{2a}\right)^2} & \\
19 &= \sqrt{\left(\frac{b^2 - 4ac}{4a^2}\right)} \notag \\
20 x + \frac{b}{2a} &= \pm \frac{\sqrt{b^2 - 4ac}}{\sqrt{4a^2}} \notag \\
21 x + \frac{b}{2a} &= \pm \frac{\sqrt{b^2 - 4ac}}{2a} \notag \\
22 x &= -\frac{b}{2a} \pm \frac{\sqrt{b^2 - 4ac}}{2a} \notag \\
23 x &= \frac{-b \pm \sqrt{b^2 - 4ac}}{2a} \\
24 \end{align}

```

Z.4.5 alignat environment

The `alignat` environment aligns multiple equations at multiple places.

$$a = b \quad \text{set } a \quad (Z.20)$$

$$c = d \quad \text{you guessed it, set } c$$

$$g = h \quad \text{and finally, set } g \quad (Z.21)$$

I like to align input columns on the input if possible and will sometimes use windows over 250 characters wide to do so. If that won't work I sometimes do, for example,

$$a = b \quad \text{set } a \quad (Z.22)$$

$$c = d \quad \text{you guessed it, set } c$$

$$g = h \quad \text{and finally, set } g \quad (Z.23)$$

Do whatever works best for you.

```
1
2 \subsection{\texttt{alignat} environment}
3 \index{\verb+\begin{aligo}+\@\verb+\begin{alignat}+}
4 \ix{alignat environment}
5
6 The \verb+alignat+ environment aligns multiple equations at multiple places.
7 \begin{alignat}{2}
8 a &= b& \quad \quad \quad \text{\text{set } $a$}\backslash\backslash
9 c &= d& \quad \quad \quad \text{\text{you guessed it, set } $c$}\backslash\text{\notag}\backslash
10 g &= h& \quad \quad \quad \text{\text{and finally, set } $g$}\backslash\backslash
11 \end{alignat}
12 \index{\verb+\begin{aligo}+\@\verb+\begin{alignat}+}
13 \ix{alignat environment}
14
15 I like to align input columns on the input if possible
16 and will sometimes use windows over-250 characters wide to do so.
17 If that won't work I sometimes do,
18 for example,
19 \begin{alignat}{2}
20 a
21 &= b
22 & \quad \quad \quad \text{\text{set } $a$}\backslash\backslash
23 & \quad \quad \quad \text{\text{set } $a$}\backslash\backslash
24 c
25 &= d
26 &
27 & \text{\text{you guessed it, set } $c$}\backslash\text{\notag}\backslash
28 g
29 &= h
30 &
31 & \text{\text{and finally, set } $g$}\backslash\backslash
32 \end{alignat}
33 \index{\verb+\begin{aligo}+\@\verb+\begin{alignat}+}
34 \ix{alignat environment}
35
36 Do whatever works best for you.
37
```

Quadratic formula proof [166]:

$ax^2 + bx + c = 0$	subtract c	(Z.24)
$ax^2 + bx = -c$	divide by a	
$x^2 + \frac{b}{a}x = -\frac{c}{a}$	add $\frac{b^2}{4a^2}$	
$x^2 + \frac{b}{a}x + \frac{b^2}{4a^2} = \frac{b^2}{4a^2} - \frac{c}{a}$	factor left hand side	
$\left(x + \frac{b}{2a}\right)^2 = \frac{b^2}{4a^2} - \frac{c}{a}$	multiply right-most term by $\frac{4a}{4a}$	
$\left(x + \frac{b}{2a}\right)^2 = \frac{b^2}{4a^2} - \frac{4ac}{4a^2}$	use common denominator	
$\left(x + \frac{b}{2a}\right)^2 = \frac{b^2 - 4ac}{4a^2}$	take square root of each side	
$\sqrt{\left(x + \frac{b}{2a}\right)^2} = \sqrt{\left(\frac{b^2 - 4ac}{4a^2}\right)}$	compute square root of each side	
$x + \frac{b}{2a} = \pm \frac{\sqrt{b^2 - 4ac}}{\sqrt{4a^2}}$	simplify right hand denominator	
$x + \frac{b}{2a} = \pm \frac{\sqrt{b^2 - 4ac}}{2a}$	subtract $\frac{b}{2a}$ from each side	
$x = -\frac{b}{2a} \pm \frac{\sqrt{b^2 - 4ac}}{2a}$	use common denominator	
$x = \frac{-b \pm \sqrt{b^2 - 4ac}}{2a}$		(Z.25)

```

1
2 Quadratic formula proof
3 \cite{khan2018}:
4
5 % Make changes to \jot be local to the group that starts on the next line.
6 {
7   % Increase distance between lines by 6pt.
8   \addtolength{\jot}{6pt}
9   \begin{alignat}{2}
10    ax^2 + bx + c
11     &= 0
12     &
13     &\text{subtract } \$c\$ \\
14    ax^2 + bx

```

```

15     &= -c
16     &
17     &\text{divide by $a$}\notag\
18 % The "\", " adds a thinspace of horizontal space.
19 x^2 + \frac ba\,x
20     &= -\frac ca
21     &
22     &\text{add $\displaystyle\frac{b^2}{4a^2}$}\notag\
23 x^2+\frac ba\,x+\frac{b^2}{4a^2}
24     &= \frac{b^2}{4a^2}-\frac ca
25     &
26     &\text{factor left hand side}\notag\
27 \left(x+\frac b{2a}\right)^2
28     &= \frac{b^2}{4a^2}-\frac ca
29     &
30     &\text{multiply right-most term by $\displaystyle\frac{4a}{4a}$}\notag\
31 \left(x + \frac b{2a}\right)^2
32     &= \frac{b^2}{4a^2}-\frac{4ac}{4a^2}
33     &
34     &\text{use common denominator}\notag\
35 \left(x + \frac b{2a}\right)^2
36     &= \frac{b^2-4ac}{4a^2}
37     &
38     &\text{take square root of each side}\notag\
39 \sqrt{\left(x + \frac b{2a}\right)^2}
40     &= \sqrt{\left(\frac{b^2-4ac}{4a^2}\right)}
41     &
42     &\text{compute square root of each side}\notag\
43 x + \frac b{2a}
44     &= \pm \frac{\sqrt{\,b^2-4ac}}{\sqrt{4a^2}}
45     &
46     &\text{simplify right hand denominator}\notag\
47 x + \frac b{2a}
48     &= \pm \frac{\sqrt{\,b^2-4ac}}{2a}
49     &
50     &\text{subtract $\displaystyle\frac b{2a}$ from each side}\notag\
51 x
52     &= -\frac b{2a} \pm \frac{\sqrt{\,b^2-4ac}}{2a}
53     &\quad
54     &\text{use common denominator}\notag\
55 x
56     &= \frac{-b \pm \sqrt{\,b^2-4ac}}{2a}
57 \end{alignat}
58 }

```

Z.4.6 flalign environment

The `flalign` environment aligns multiple equations at multiple places on full length lines.

$$\begin{array}{llll}
 a = b & & & u = v \quad (\text{Z.26}) \\
 c = d & & m = n & w = x \\
 g = h & & & y = z \quad (\text{Z.27})
 \end{array}$$

```

1
2 \index{\verb+\begin{flalign}+}

```



```

3 \todoindex{Verb+Begin-Ocurly-flalign-Ccurly+}
4 \ix{falign environment}
5 \subsection{\texttt{falign} environment}
6
7 The \verb+falign+ environment aligns multiple equations at multiple places
8 on full length lines.
9
10 \begin{falign}
11   a &= b& \quad & u &= v\\
12   c &= d& m &= n& w &= x\notag\\
13   g &= h& \quad & & y &= z
14 \end{falign}

```

Z.4.7 split environment

The split environment ???.

```

1
2 \index{\verb+\begin{split}+}
3 \todoindex{Verb+Begin-Ocurly-split-Ccurly+}
4 \ix{split environment}
5 \subsection{\texttt{split} environment}
6
7 The \verb+split+ environment ???.
```

Z.5 Theorem-like environments

These theorem-like environments are defined in the amsthm package or in `PurdueThesis.cls`.

```

1 \section{Theorem-like environments}
2
3 These theorem-like environments are defined
4 in the amsthm package or in\ \ % break line here so we don't go past right margin
5 \verb+PurdueThesis.cls+.
```

Definition Z.5.1. *This is an example definition. This is an example definition. This is an example definition. This is an example definition. This is an example definition.*

Observation Z.5.1. *This is an example observation. This is an example observation. This is an example observation. This is an example observation. This is an example observation.*

Proof. This is an example proof. This is an example proof. This is an example proof. This is an example proof. If $a = b$ and $b = c$ then $a = c$. □

Proposition Z.5.1. *This is an example proposition. This is an example proposition. This is an example proposition. This is an example proposition. This is an example proposition.*

Theorem Z.5.1. *This is an example theorem. This is an example theorem. This is an example theorem. This is an example theorem. This is an example theorem. This is an example theorem.*

```

1
2 \index{\verb+\begin{definition}+}
3 \todoindex{Verb+Begin-0curly-definition-Ccurly+}
4 \ix{definition environment}
5 \begin{definition}
6   This is an example definition.
7   This is an example definition.
8   This is an example definition.
9   This is an example definition.
10  This is an example definition.
11 \end{definition}
12
13 \index{\verb+\begin{observation}+}
14 \todoindex{Verb+Begin-0curly-observation-Ccurly+}
15 \ix{observation environment}
16 \begin{observation}
17   This is an example observation.
18   This is an example observation.
19   This is an example observation.
20   This is an example observation.
21   This is an example observation.
22 \end{observation}
23
24 \index{\verb+\begin{proof}+}
25 \todoindex{Verb+Begin-0curly-proof-Ccurly+}
26 \ix{proof environment}
27 \begin{proof}
28   This is an example proof.
29   This is an example proof.
30   This is an example proof.
31   This is an example proof.
32   If  $(a = b)$  and  $(b = c)$  then  $(a = c)$ .
33 \end{proof}
34
35 \index{\verb+\begin{proposition}+}
36 \todoindex{Verb+Begin-0curly-proposition-Ccurly+}
37 \ix{proposition environment}
38 \begin{proposition}
39   This is an example proposition.
40   This is an example proposition.
41   This is an example proposition.
42   This is an example proposition.
43   This is an example proposition.
44 \end{proposition}
45
46 \index{\verb+\begin{theorem}+}
47 \todoindex{Verb+Begin-0curly-theorem-Ccurly+}
48 \ix{theorem environment}
49 \begin{theorem}
50   This is an example theorem.
51   This is an example theorem.
52   This is an example theorem.
53   This is an example theorem.
54   This is an example theorem.
55 \end{theorem}

```

Z.6 Examples

Z.6.1 Bayes' Theorem

Bayes' Theorem [167]:

$$P(A|B) = \frac{P(B|A)P(A)}{P(B)}$$

```
1
2
3 \section{Examples}
4
5 \subsection{Bayes' Theorem}
6 \ix{Bayes' Theorem}
7
8 Bayes' Theorem
9 \cite{bayes}:
10
11 {
12   \UndefShortVerb{\|}
13   \[
14     \text{P}(\text{A}|\text{B})
15     % The "\", puts a thin horizontal space there, 1/6 of an "em".
16     % An "em" is roughly the width of a lowercase "m".
17     = \frac{\text{P}(\text{B}|\text{A})\text{P}(\text{A})}{\text{P}(\text{B})}
18   \]
19 }
```

Z.6.2 Nicomachus's theorem

Nicomachus's theorem [168] states that the sum of the first n cubes is the square of the n th triangular number. That is,

$$1^3 + 2^3 + 3^3 + \cdots + n^3 = (1 + 2 + 3 + \cdots + n)^2.$$

The same equation may be written more compactly using the mathematical notation for summation:

$$\sum_{k=1}^n k^3 = \left(\sum_{k=1}^n k \right)^2.$$

Also see the diagram on that web page.

```
1
2 \subsection{Nicomachus's theorem}
3 \ix{Nicomachus's theorem}
4
5 Nicomachus's theorem
6 \cite{wikipedia-nicomachus}
7 states that
8 the sum of the first-$n$ cubes is the square of the-$n$th triangular number.
9 That is,
10 \[
11   1^3 + 2^3 + 3^3 + \cdots + n^3 = (1 + 2 + 3 + \cdots + n)^2.
```

```

12 \]
13 The same equation may be written more compactly using the mathematical notation for summation:
14 \[
15 \sum_{k=1}^n k^3 = \left(\sum_{k=1}^n k\right)^2.
16 \]
17 Also see the diagram on that web page.

```

Z.6.3 Prime Number Theorem

Li [169] suggested using a functional equation from the Prime Number Theorem proof as an example:

$$\int_1^x \sum_{p \leq u} \left[\frac{\log u}{\log p} \right] \log p \, du = \frac{1}{2\pi i} \int_{c-i\infty}^{c+i\infty} \frac{x^{s+1}}{s(s+1)} \left(-\frac{\zeta'(s)}{\zeta(s)} \right) ds \quad (\text{Z.28})$$

```

1
2 \subsection{Prime Number Theorem}
3 \ix{Prime Number Theorem}
4
5 \textcite{li2013}
6 suggested using a functional equation
7 from the Prime Number Theorem proof
8 as an example:
9 \begin{equation}
10 \int_1^x
11 \sum_{p \leq u}
12 \left\lfloor \frac{\log u}{\log p} \right\rfloor
13 \log p
14 \, \text{d}u
15 =
16 \frac{1}{2\pi i}
17 \int_{c-i\infty}^{c+i\infty}
18 \frac{x^{s+1}}{s(s+1)}
19 \left( -\frac{\zeta'(s)}{\zeta(s)} \right)
20 \text{d}s
21 \end{equation}

```

Z.6.4 Quantum Mechanics

Greene [170] wrote

Quantum Mechanics in a nutshell: A particle goes from here to there by sampling every possible trajectory from here to there.

$$\langle x_f, t_f | x, t_i \rangle = \sum_{p \in \text{paths}} e^{iS(p)\hbar}$$

```

1
2 \subsection{Quantum Mechanics}
3 \ix{Quantum Mechanics}
4
5 \textcite{greene-2021-04-04}
6 wrote
7 \ix{Greene, Brian Randolph}
8 \begin{quotation}

```

```

9 Quantum Mechanics in a nutshell:
10 A particle goes from here to there
11 by sampling every possible trajectory from here to there.
12
13 \[
14 \langle x_f, t_f \rangle \text{vert } x, t_{\mathit{i}} \rangle \rangle
15 =
16 \sum_{\text{p}} \int \text{paths} e^{iS(\text{p})} \hbar
17 \]
18 \end{quotation}

```

Z.6.5 Question in String Theory / Mass of States / Number Operator

yourlazyphysicist [171] wrote “I have the following definition of the space-time coordinates”:

$$\text{closed string: } \begin{cases} X_R^\mu = \frac{1}{2}x^\mu + \frac{1}{4\pi T}(\tau - \sigma)p^\mu + \frac{i}{\sqrt{4\pi T}} \sum_{n \neq 0} \frac{1}{n} \alpha_n^\mu e^{-in(\tau - \sigma)}, \\ X_L^\mu = \frac{1}{2}x^\mu + \frac{1}{4\pi T}(\tau + \sigma)p^\mu + \frac{i}{\sqrt{4\pi T}} \sum_{n \neq 0} \frac{1}{n} \tilde{\alpha}_n^\mu e^{-in(\tau + \sigma)}. \end{cases} \quad (\text{Z.29})$$

$$\text{open string: } \begin{cases} X_N^\mu = x^\mu + \frac{1}{\pi T}p^\mu \tau + \frac{i}{\sqrt{\pi T}} \sum_{n \neq 0} \frac{1}{n} \alpha_n^\mu e^{-in\tau} \cos(n\sigma), \\ X_D^\mu = x^\mu + \frac{i}{\sqrt{\pi T}} \sum_{n \neq 0} \frac{1}{n} \alpha_n^\mu e^{-in\tau} \sin(n\sigma). \end{cases} \quad (\text{Z.30})$$

```

1 \subsection{Question in String Theory / Mass of States / Number Operator}
2
3
4 \textcite{yourlazyphysicist2017}
5 wrote
6 ‘‘I have the following definition of the space-time coordinates’’:
7
8 \newcommand{\fpt}{4\pi T}
9 \newcommand{\oh}{\frac{1}{2}}
10 \newcommand{\snnz}{\sum_{n \neq 0}}
11 \newcommand{\tms}{\tau - \sigma}
12 \newcommand{\tps}{\tau + \sigma}
13 \begin{align}
14 \text{closed string: } & \&
15 \begin{cases}
16 \displaystyle
17 X^\mu_R
18 = \oh x^\mu
19 + \frac{1}{\fpt} (\tms) p^\mu
20 + \frac{i}{\sqrt{\fpt}} \snnz \frac{1}{n} \alpha_n^\mu e^{-in(\tms)}, \\
21 \displaystyle
22 X^\mu_L
23 = \oh x^\mu
24 + \frac{1}{\fpt} (\tps) p^\mu
25 + \frac{i}{\sqrt{\fpt}} \snnz \frac{1}{n} \tilde{\alpha}_n^\mu e^{-in(\tps)}.
26 \end{cases} \\
27 \text{open string: } & \&
28 \begin{cases}
29 \displaystyle

```

```

30      X^{\mu_N}
31      = x^{\mu}
32      + \frac{1}{\sqrt{\pi T}} p^{\mu} \tau
33      + \frac{i}{\sqrt{\pi T}} \operatorname{snnz} \frac{1}{n} \alpha^{\mu_n} e^{-in\tau} \cos(n\sigma), \backslash
34      \displaystyle
35      X^{\mu_D}
36      = x^{\mu}
37      + \frac{i}{\sqrt{\pi T}} \operatorname{snnz} \frac{1}{n} \alpha^{\mu_n} e^{-in\tau} \sin(n\sigma).
38  \end{cases}
39  \end{align}

```

AA. MUSIC

To get the following printed music score I did the following steps.

- Get the “Example of LilyPond input file” from the Wikipedia LilyPond page [172] and put it in a `fib.ly` file.
- Ran `lilypond fib.ly` and got the following `fib.pdf` file:

Excerpt from *fibonacci*

Patrick McCarty

Slow and steady ($\text{♩} = 60$)

57

Music engraving by LilyPond 2.22.0—www.lilypond.org

```
1 \chapter{MUSIC}
2 \ix{music//Music appendix}
3
4 To get the following printed music score I did the following steps.
5 \begin{itemize}
6   \item
7     Get the ‘‘Example of LilyPond input file’’
8     from the Wikipedia LilyPond page
9     \cite{wikipedia-lilypond}
10    and put it in a \verb+fib.ly+ file.
11   \item
12     Ran \verb+lilypond fib.ly+ and got the following \verb+fib.pdf+ file:
13 \end{itemize}
14 \ix{LilyPond music typesetting software}
15
16 \noindent \includegraphics[scale=0.77]{gr-fib.pdf}
```

VITA

[Put a brief autobiographical sketch here.]

PUBLICATION(S)

The following is based on information in [173]–[175].

In a publication or publications section you can

- list a single publication
- include a single publication
- list multiple publications
- include multiple publications

Use

```
\begin{publication}... \end{publication}
```

or

```
\begin{publications}... \end{publications}
```

to skip to the next page and put the appropriate heading on the top of the page.

To List a Single Publication

```
\begin{publication}
...list a single publication here...
...IMPROVE THIS LATER to show how to do that...
\end{publication}
```

To Include a Single Publication

```
\begin{publication}
...put a single publication here...
...IMPROVE THIS LATER to show how to do that...
\end{publication}
```

To List Multiple Publications

```
\begin{publications}
...list multiple publications here...
...IMPROVE THIS LATER to show how to do that...
\end{publications}
```

To Include Multiple Publications

```
\begin{publications}
...put the multiple publications here...
...IMPROVE THIS LATER to show how to do that...
\end{publications}
```

INDEX

, (comma), 27
␣ (visible space), 27
. (period), 31
???, ???, 98
CircuitikZ, 171
 \sqcup , 31
 \setminus , 188
 $\@$, 31
 \Pr , 179
 \arccos , 179
 \arcsin , 179
 \arctan , 179
 \arg , 179
 \begin{align} , 188
 $\begin{alignat}$, 190
 $\begin{definition}$, 193
 $\begin{description}$, 154
 $\begin{enumerate}$, 154
 $\begin{flalign}$, 192
 $\begin{itemize}$, 154
 $\begin{observation}$, 193
 \begin{proof} , 193
 $\begin{proposition}$, 193
 $\begin{publication}$, 201
 $\begin{publications}$, 201
 \begin{split} , 193
 \begin{table} , 131
 $\begin{tabular}$, 66, 149
 $\begin{theorem}$, 193
 \begin{vita} , 200
 \bottomrule , 131
 $\char'40$, 27
 \cos , 179
 \cosh , 179
 \cot , 179
 \coth , 179
 \csc , 179
 \deg , 179
 \det , 179
 \dim , 179
 \exp , 179
 \footnote , 151
 \frenchspacing , 157
 \gcd , 179
 \hom , 179
 \inf , 179
 \ker , 179
 \lg , 179
 \lim , 179
 \liminf , 179
 \limsup , 179
 \ln , 179
 \log , 179
 \max , 179
 \midrule , 131
 \min , 179
 \nonfrenchspacing , 157
 \sec , 179
 \sin , 179
 \sinh , 179
 \sup , 179
 \tan , 179
 \tanh , 179
 \toprule , 131
~ (tilde), 31
algorithm, 170
align environment, 188
alignat environment, 190
alpha, 150
arccos, 179
arcsin, 179
arctan, 179
arg, 179
astronomy, 161
Astronomy appendix, 161
Bayes' Theorem, 195
beta, 150
Biology appendix, 162
camelCase, 30
chemistry, 163
Chemistry appendix, 163
chi, 150
clock TikZ example, 91
comma, 27

computer science, 170
 Computer Science appendix, 170
 cos, 179
 cosh, 179
 cot, 179
 coth, 179
 Counter TikZ example, 93
 cryptocode, 170
 csc, 179

 dash, 32, 33

- emdash, 32
- endash, 32
- figure dash, 33
- hyphen, 32
- minus sign, 33

 definition environment, 193
 deg, 179
 delta, 150
 description environment, 154
 det, 179
 dim, 179
 Dr. Smith, 31

 e.g., 63
 electrical engineering, 171
 Electrical Engineering appendix, 171
 emdash, 32
 endash, 32
 enumerate environment, 154
 epsilon, 150
 et al., 63
 eta, 150
 exp, 179

 falign environment, 192
 figure

- $\sqrt{2}$, 73
- placement specifiers (b, h, p, t, !), 66
- subfigures
 - 1 row \times 2 columns, 70
 - 2 rows \times 1 column, 71
 - 2 rows \times 2 columns, 71

 figure dash, 33
 filenames, 30

 footnote, 151
 Fourier transform TikZ example, 94
 frenchspacing, 157

 gamma, 150
 gcd, 179
 glider TikZ example, 97
 Greene, Brian Randolph, 196

 Hirzel, Alex, 97
 hom, 179
 hyphen, 32

 i.e., 64
 inf, 179
 initials, 31
 iota, 150
 itemize environment, 154

 Jaramillo, Ramón, 171

 kappa, 150
 kebab-case, 30
 ker, 179
 Kristensen, Thomas G., 99

 lambda, 150
 lg, 179
 LilyPond music typesetting software, 199
 lim, 179
 liminf, 179
 limsup, 179
 Lingner, Burkart, 172
 linguistics, 177
 Linguistics appendix, 177
 ln, 179
 log, 179

 Mathematica, 100
 mathematics, 178
 Mathematics appendix, 178
 MATLAB programming language, 82
 max, 179
 METAPOST, 83
 min, 179
 minus sign, 33
 miscellaneous, 105

Miscellaneous appendix, 105
 mu, 150
 music, 199
 Music appendix, 199

 NASA, 31
 Nicomachus’s theorem, 195
 nonfrenchspacing, 157
 nu, 150

 observation environment, 193
 omega, 150
 omicron, 150

 PascalCase, 30
 period
 space after, 31
 phi, 150
 pi, 150
 Pr, 179
 Prime Number Theorem, 196
 proof environment, 193
 proposition environment, 193
 protocol, 170
 pseudocode, 170
 psi, 150
 publication environment, 201
 publications environment, 201
 Python programming language, 88

 quadratic formula, 188
 Quantum Mechanics, 196

 R programming language, 89
 Redaelli, Massimo A., 171
 rho, 150

 sec, 179
 serial comma, 27
 sigma, 150
 sin, 179
 sinh, 179
 Smith, 31
 snake_case, 30
 spacing
 after period, 31
 special characters, 149
 Special Characters appendix, 149
 split environment, 193
 subfigure, *see* figure, subfigures
 sup, 179

 table, 131
 Taijitu symbol, 99
 tan, 179
 tanh, 179
 tau, 150
 Testing chapter, 150
 Text, 154
 theorem environment, 193
 theta, 150
 thin space, 188
 TikZ, 91, 99
 TikZ L^AT_EX package, 91
 tilde (~), 31
 tree TikZ example, 98

 upsilon, 150

 vita, 200
 Voss, Herbert, 131

 Wolfram Language, 100

 xi, 150

 Yin and yang symbol, 99

 zeta, 150